

LEGENDS OF

TM

# CHIMA

70010



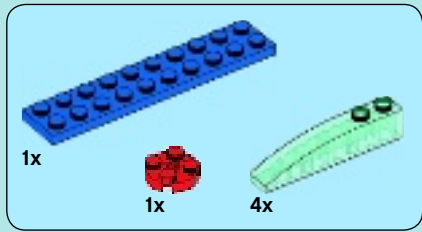

68

1

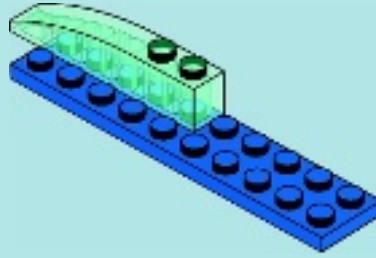

2

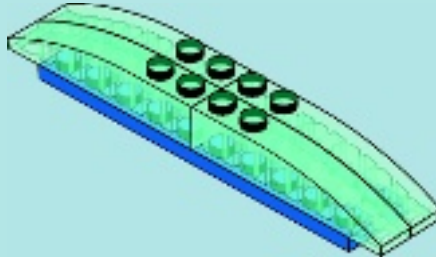

3

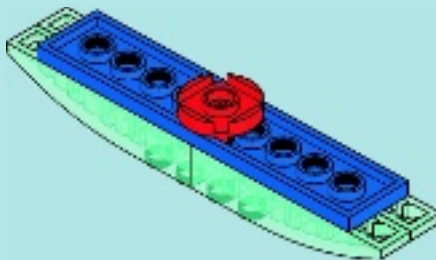
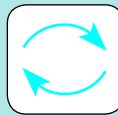

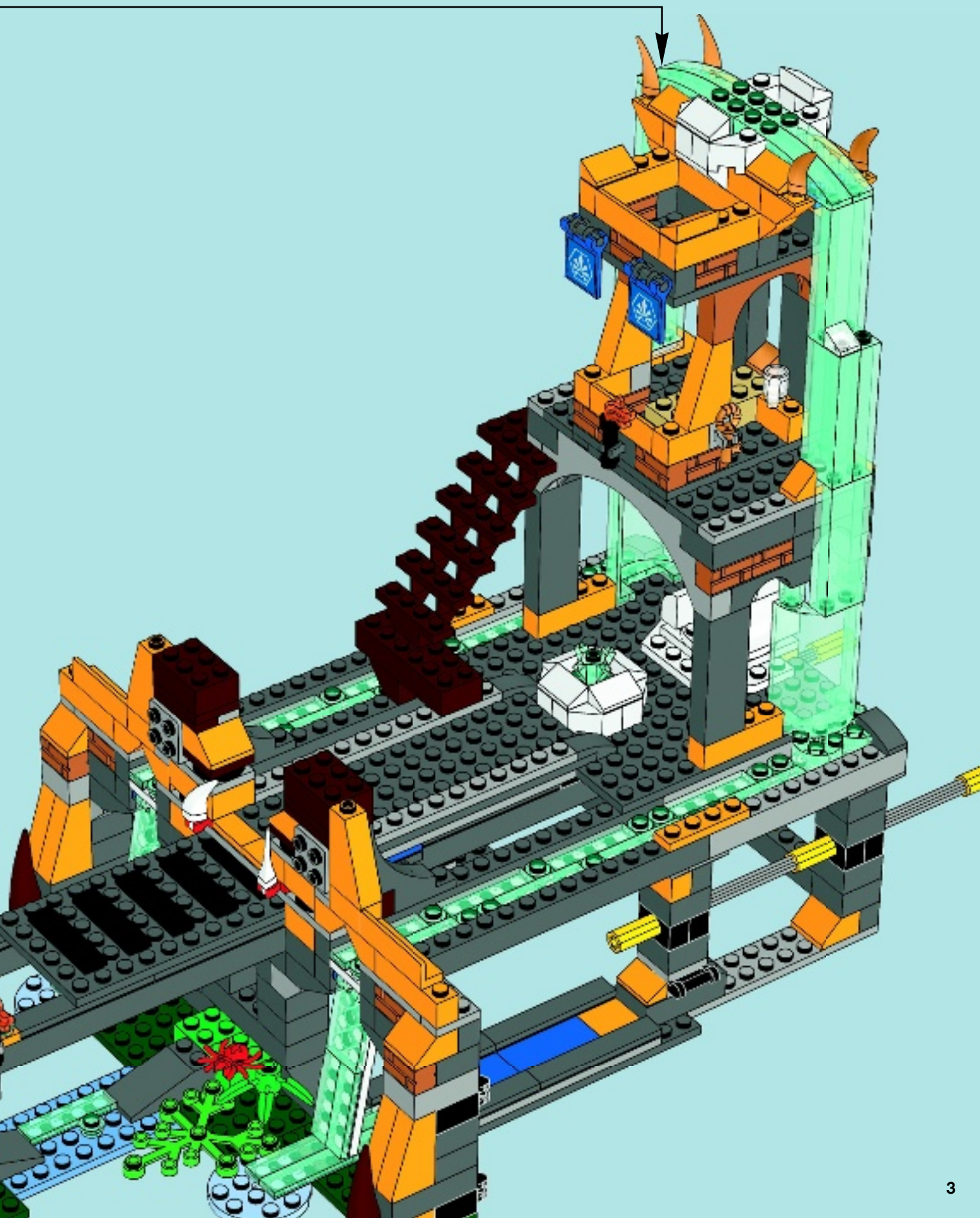



# 69

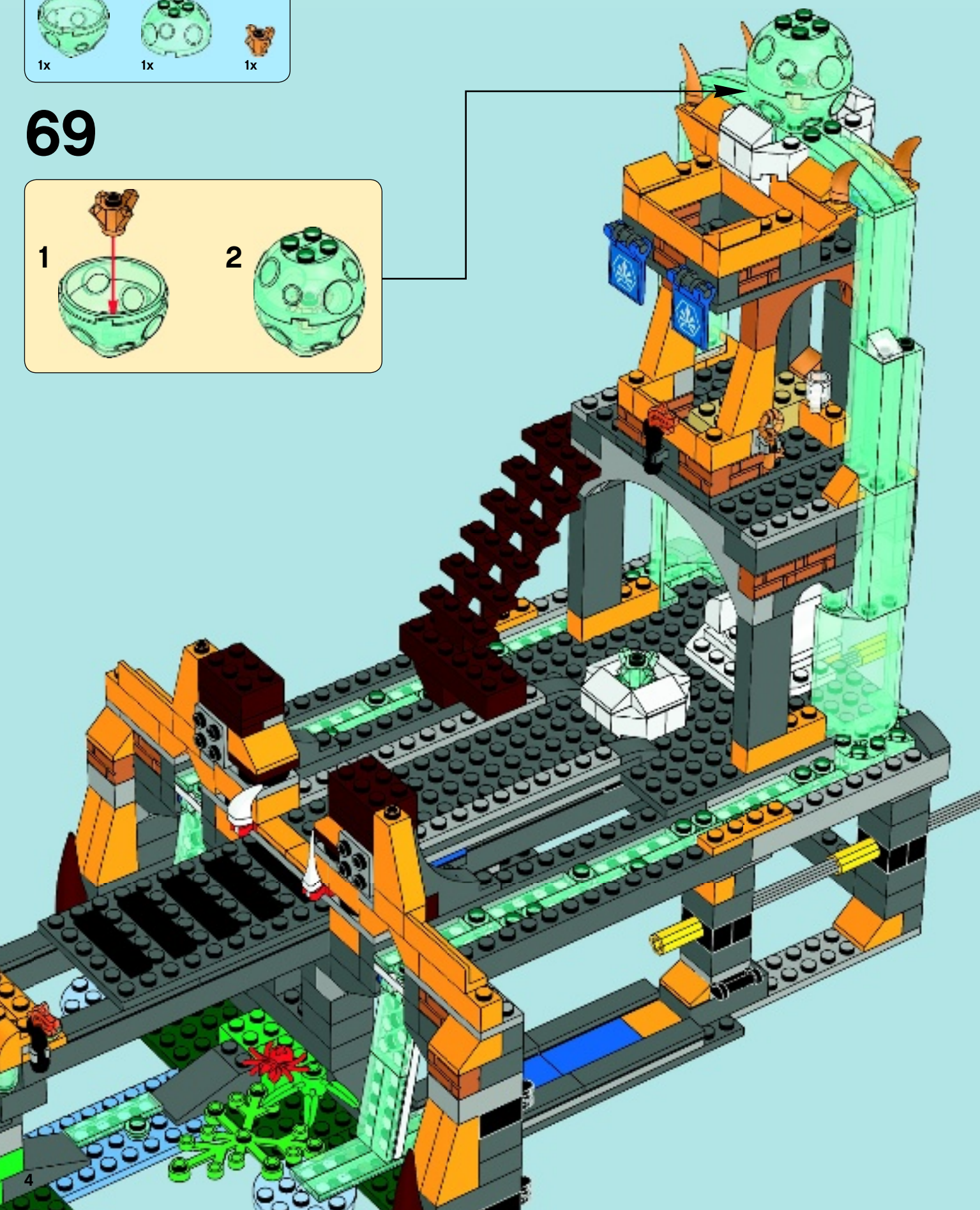
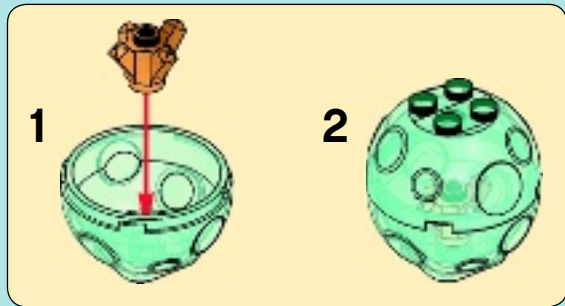

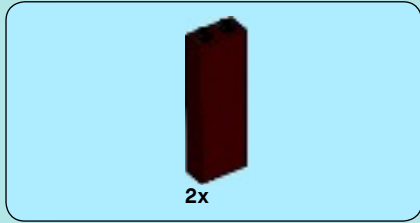
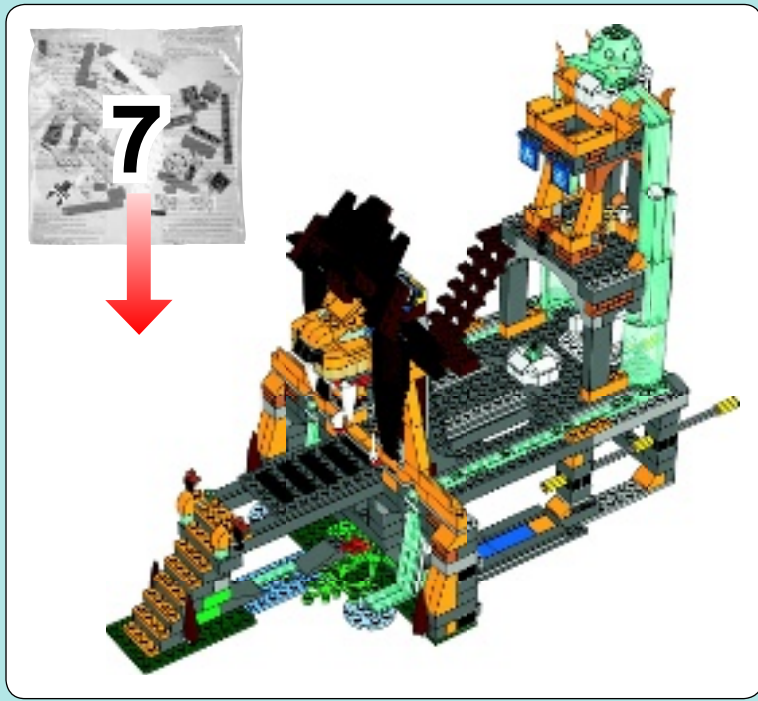

70

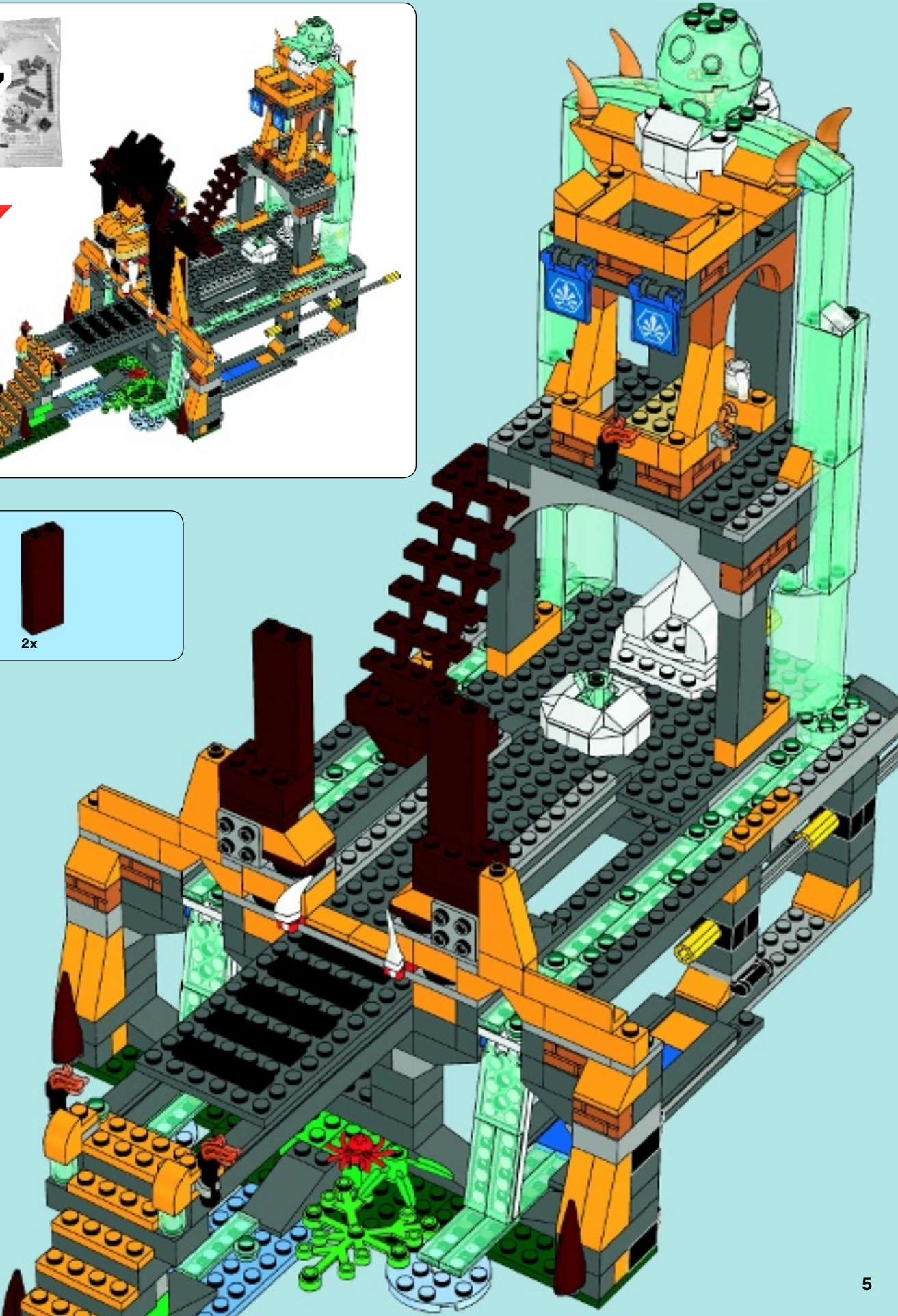

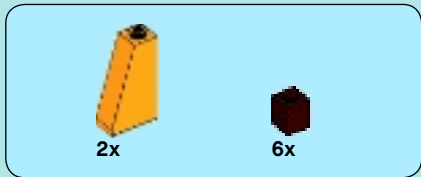

# 71

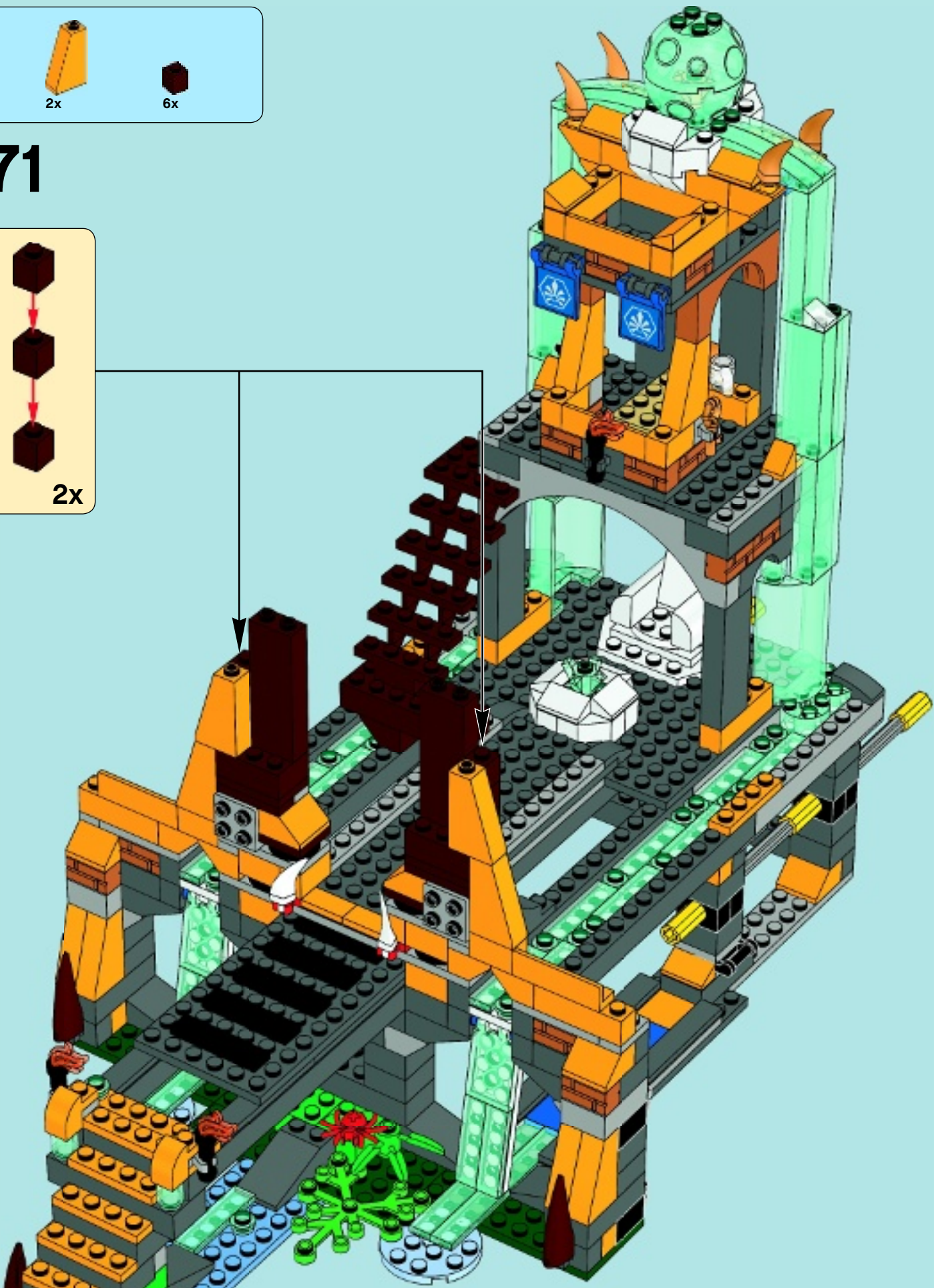
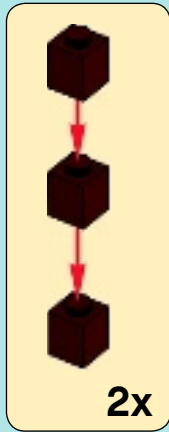

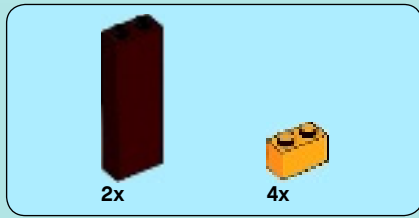

# 72

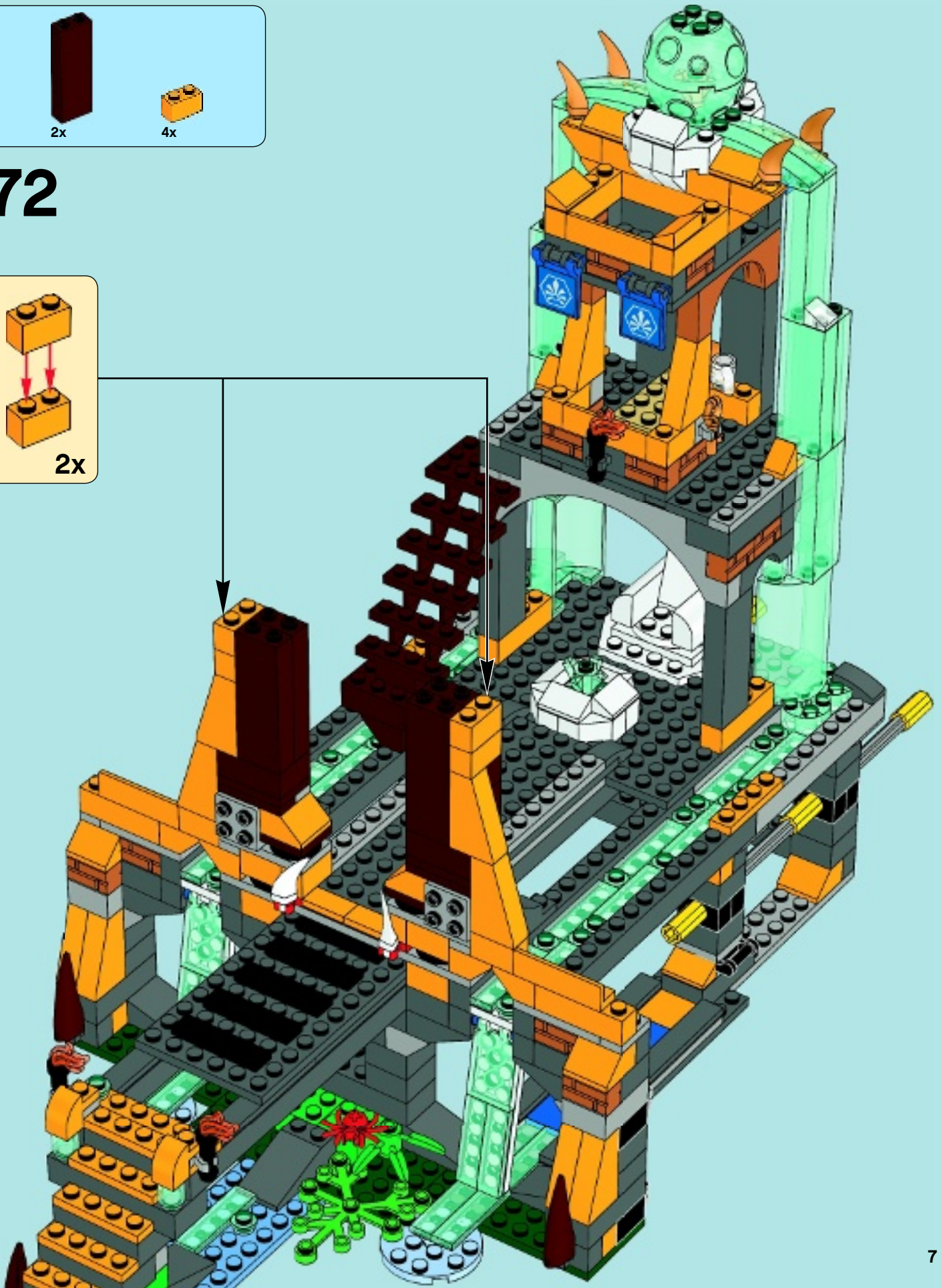
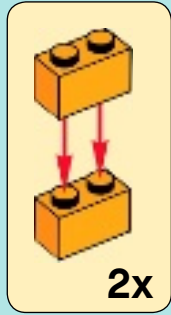

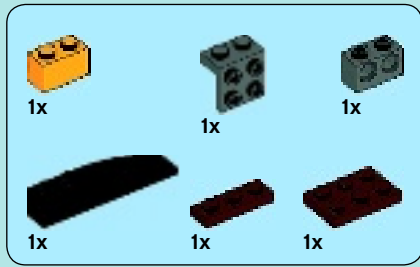

73

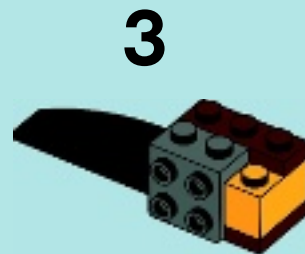
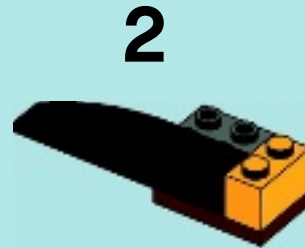
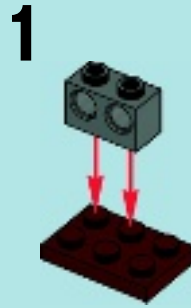



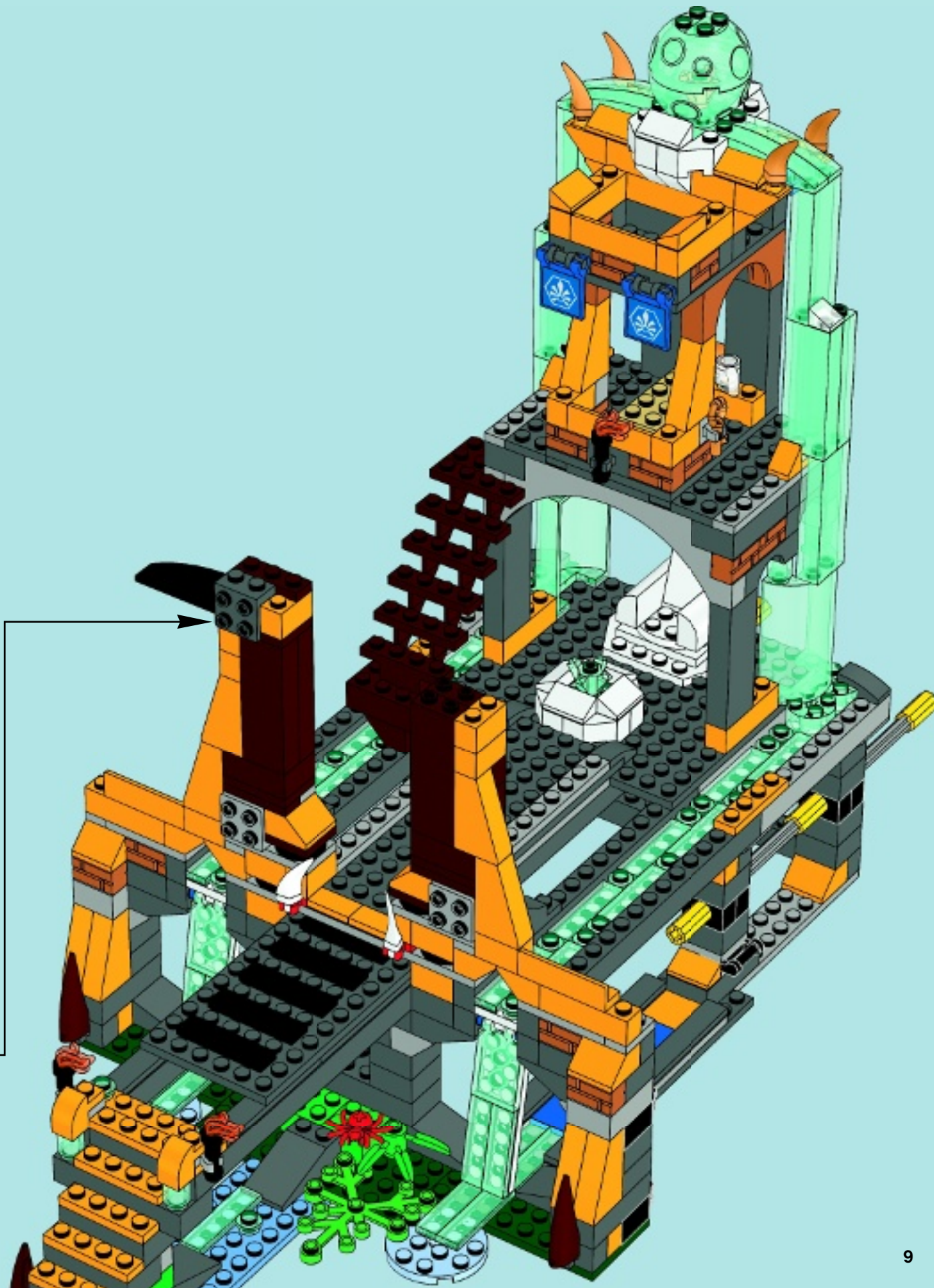

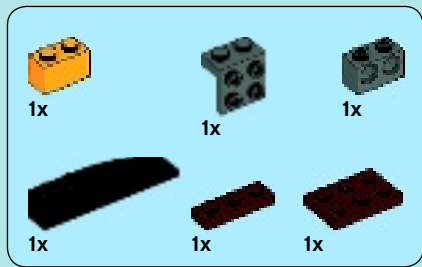

74

1

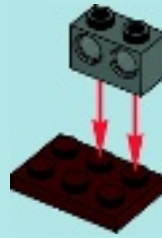

2



3

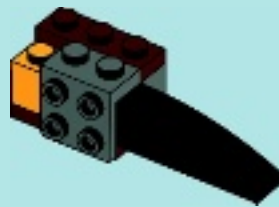

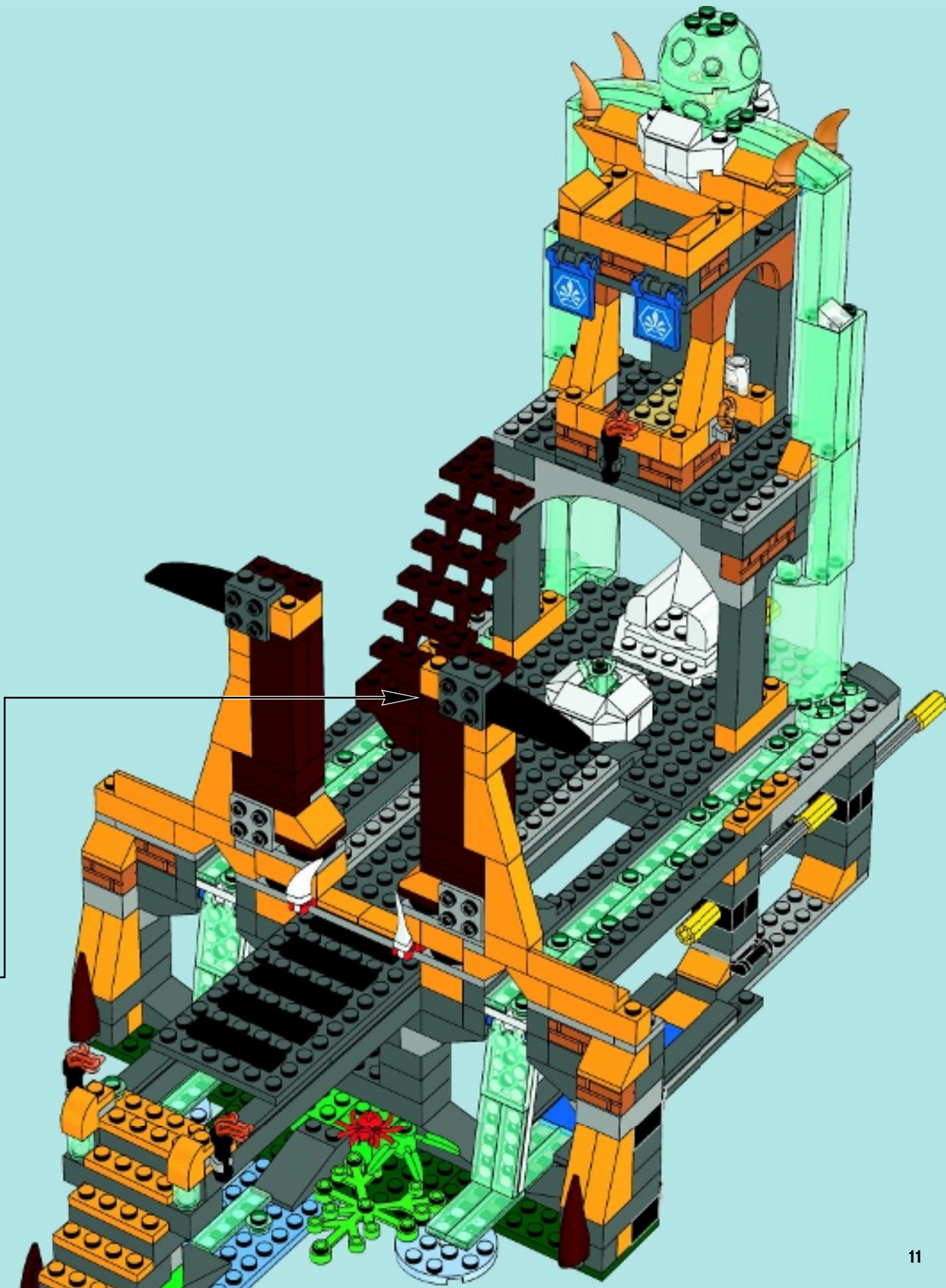

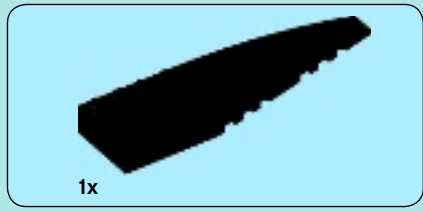

75

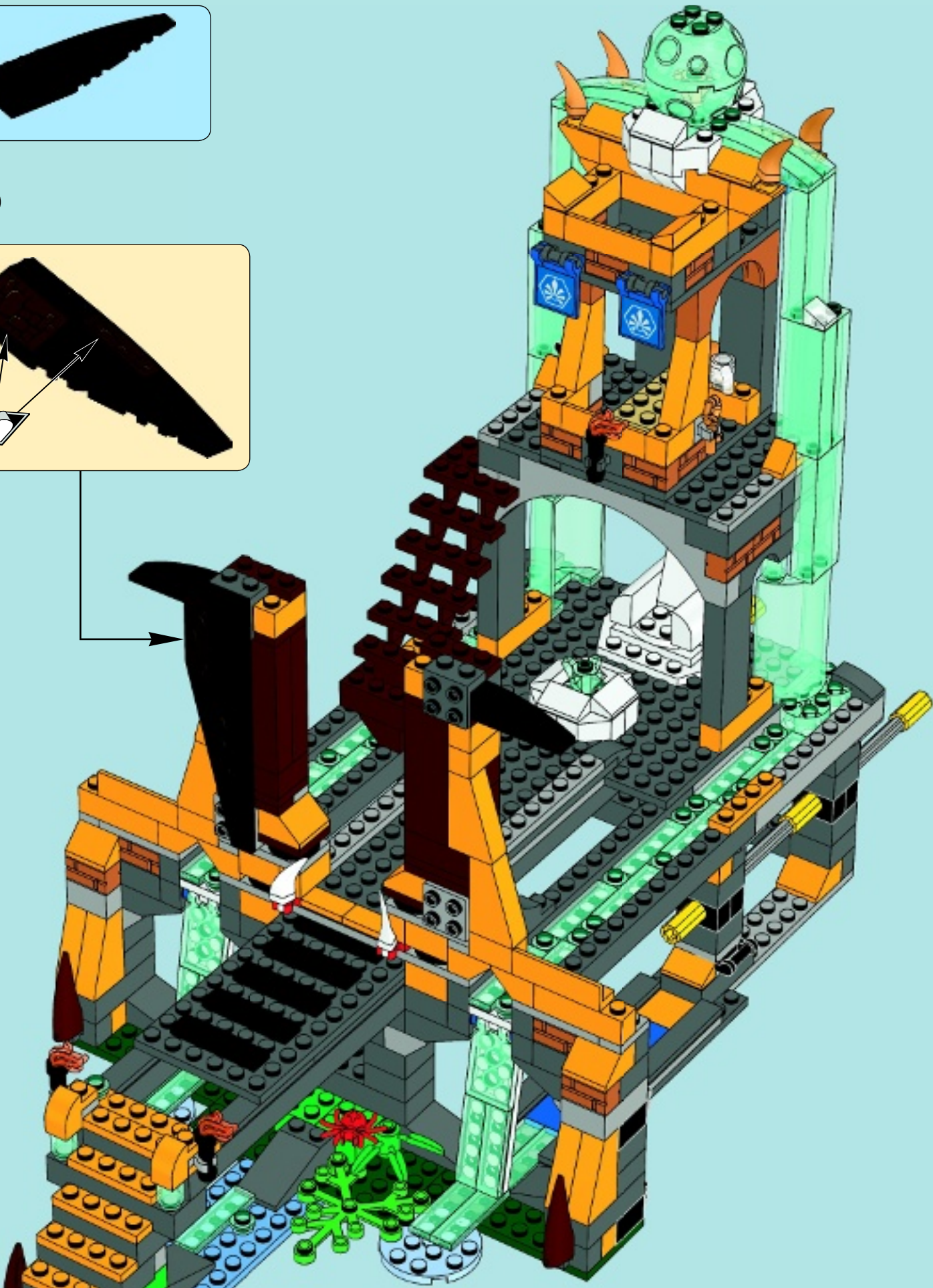
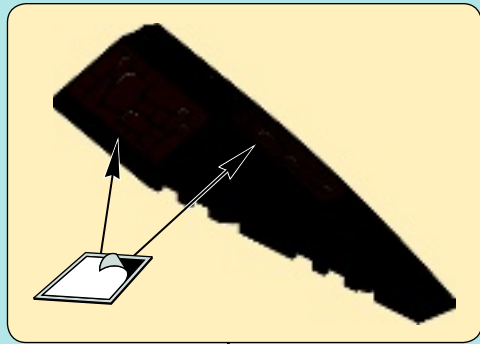



76

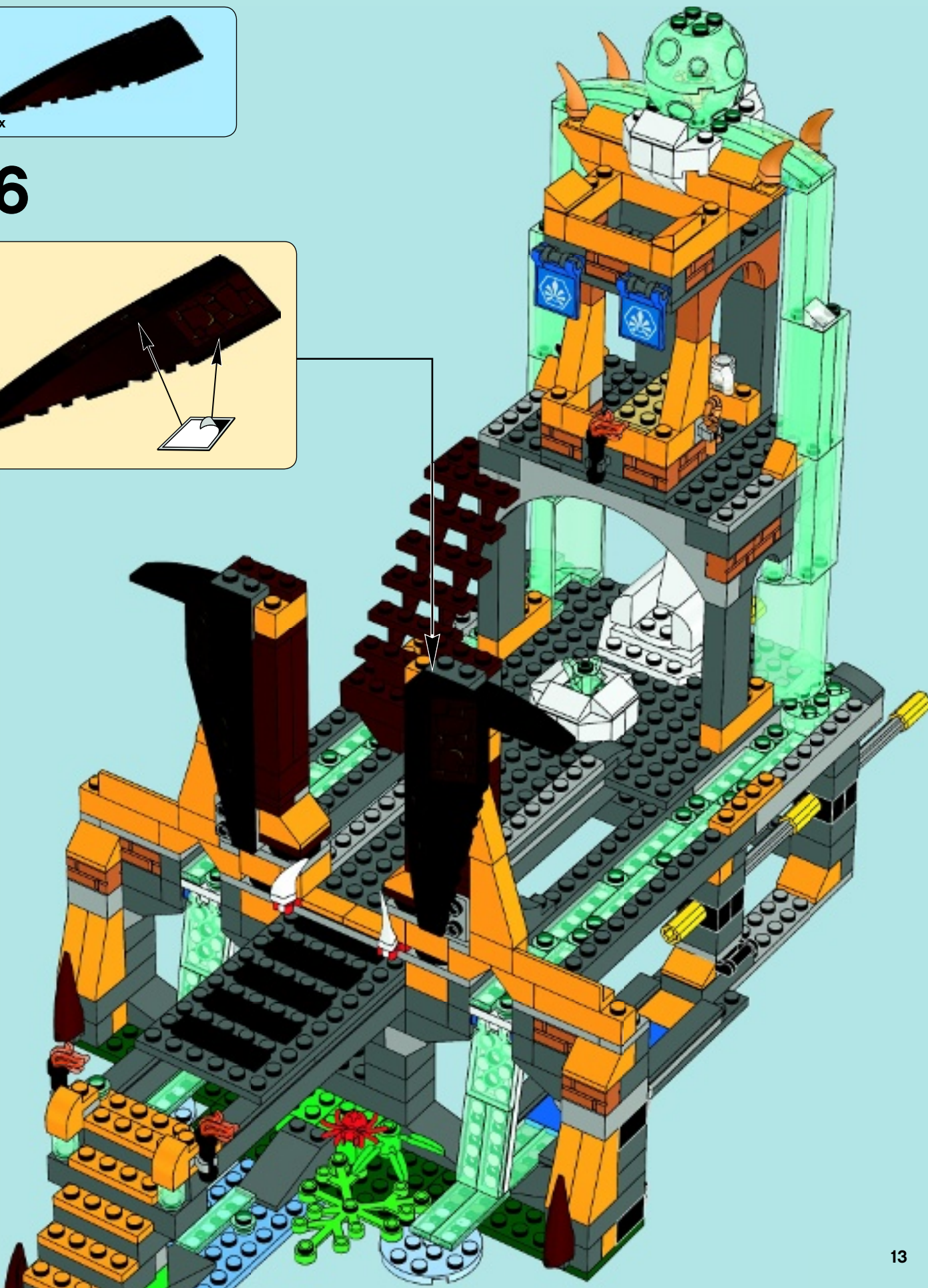
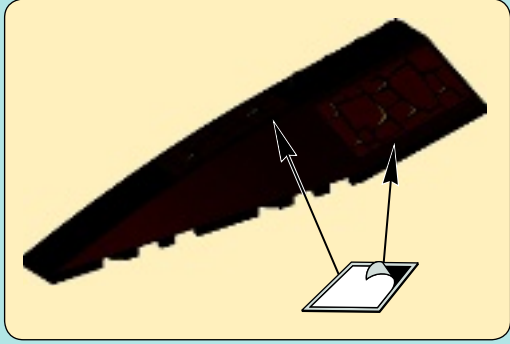

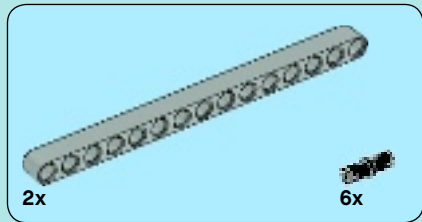

77

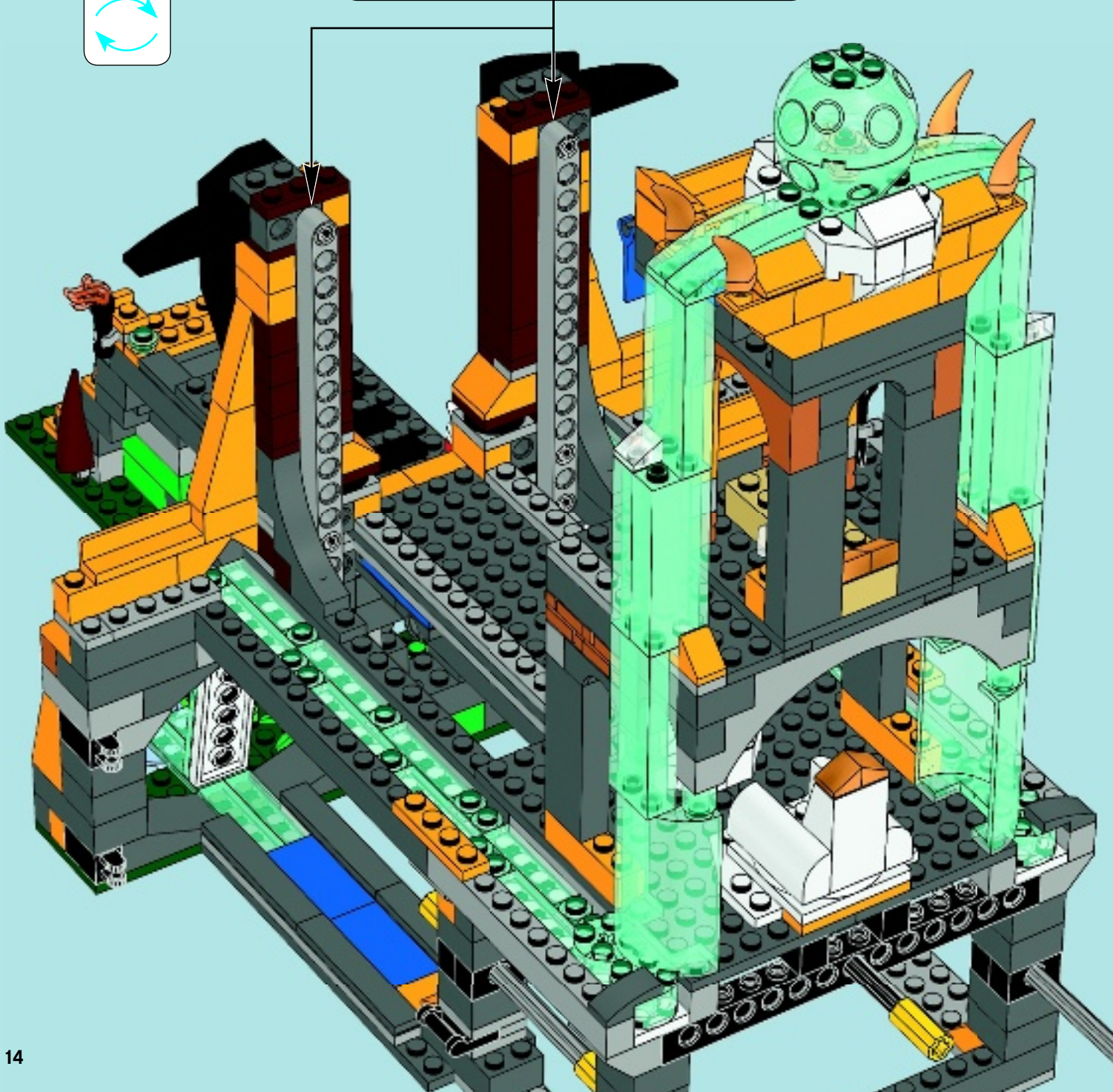
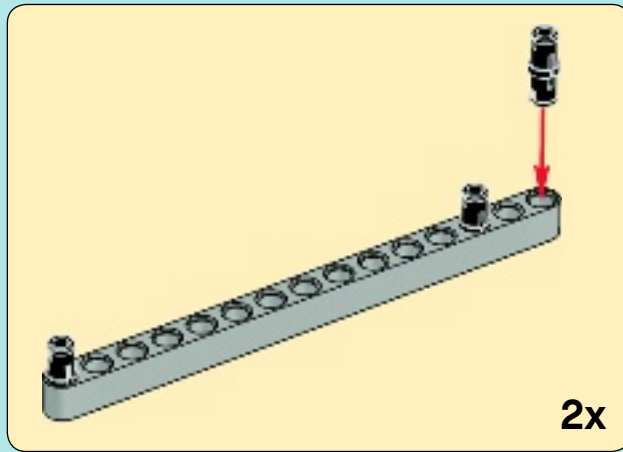

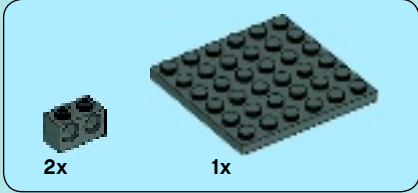
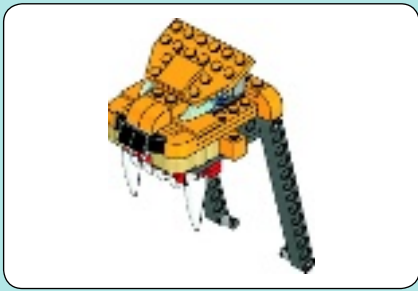

1

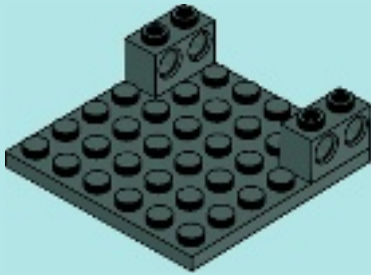

2

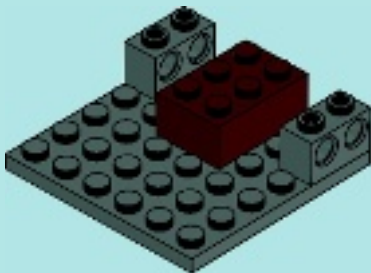

3

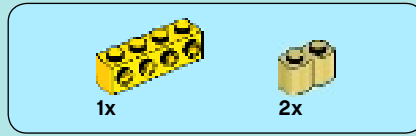
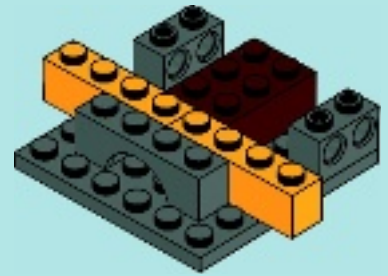

4



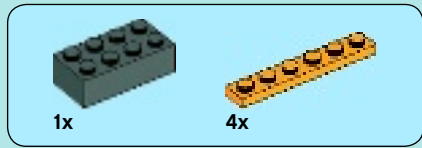

5

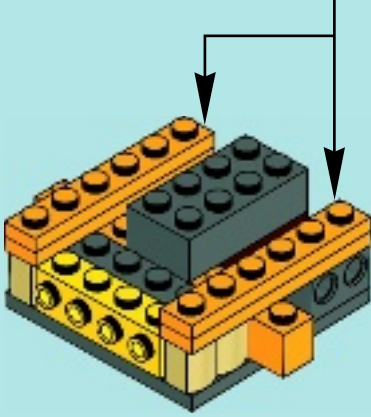
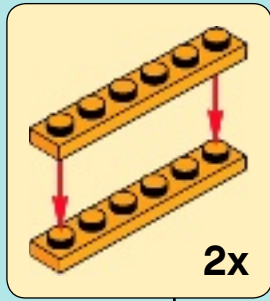

6

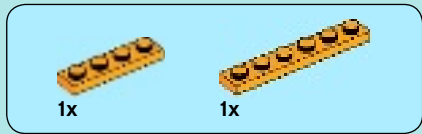
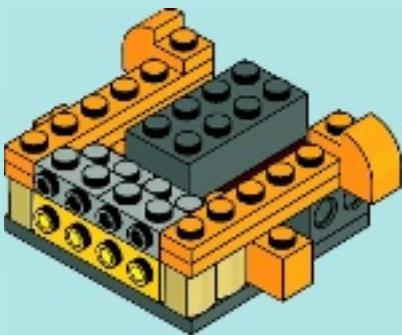

7

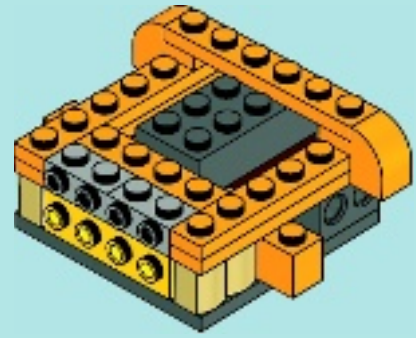

8

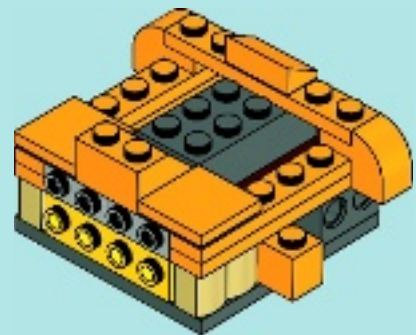



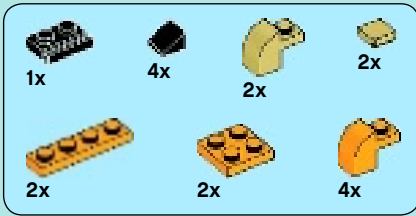

# 9

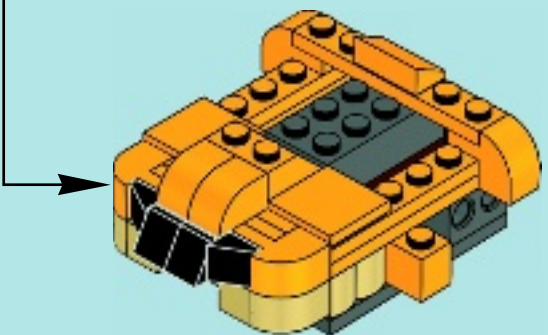
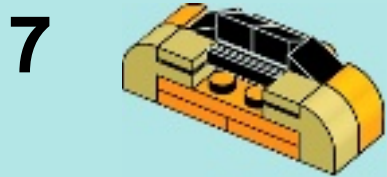
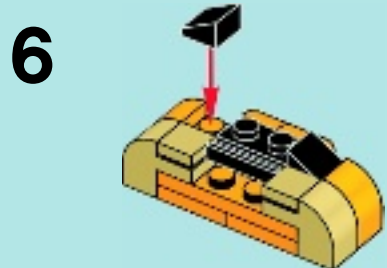
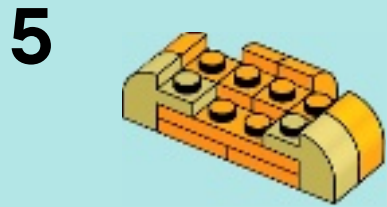
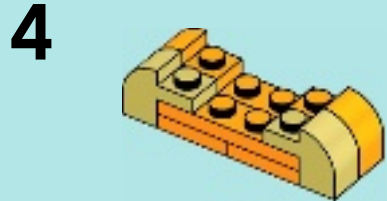
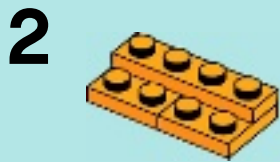
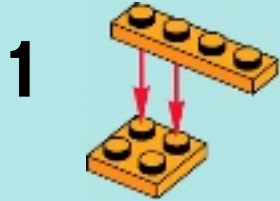

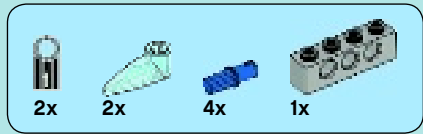

# 10

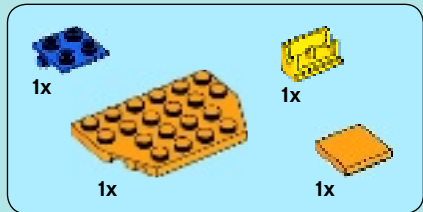
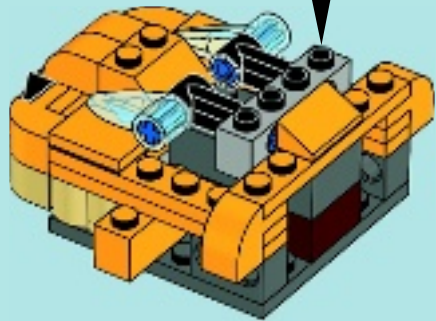
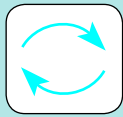
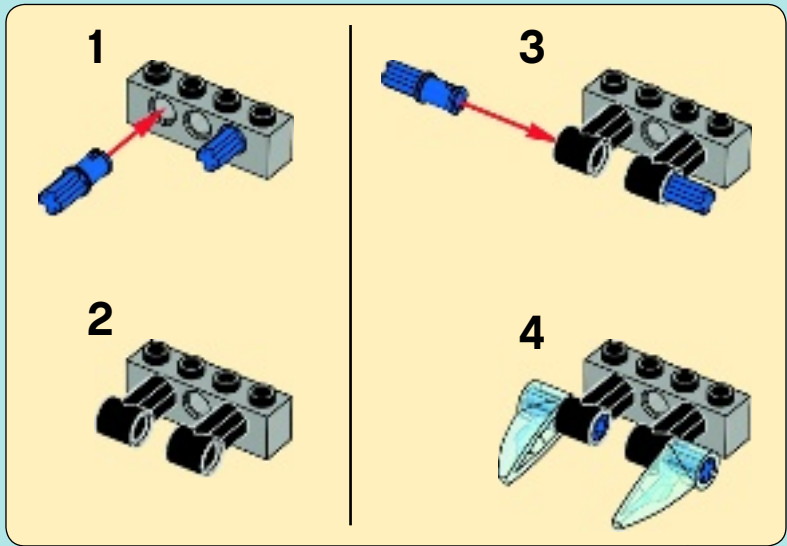

# 11

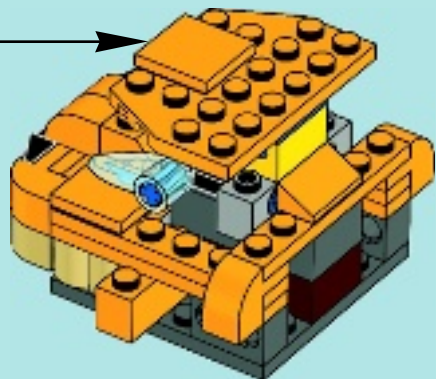

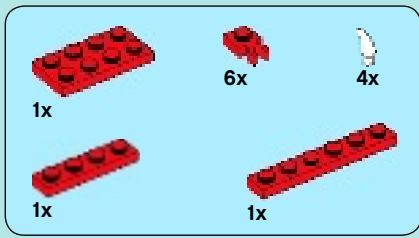

# 12

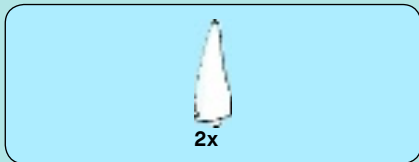
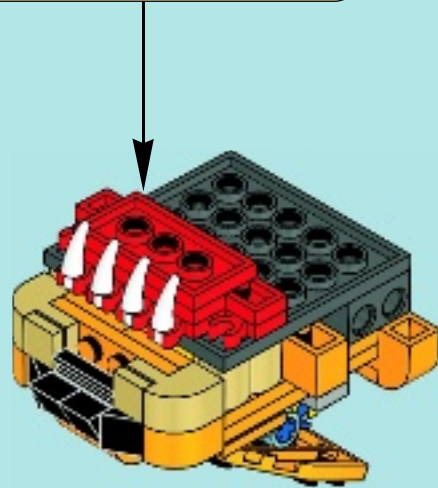
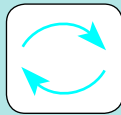
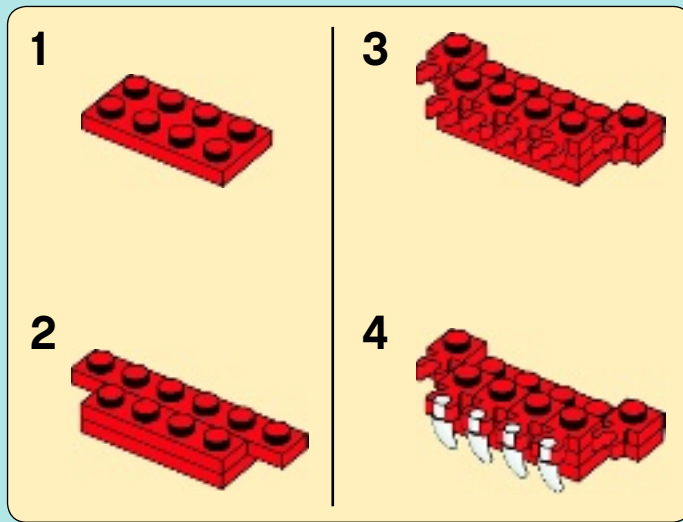

# 13

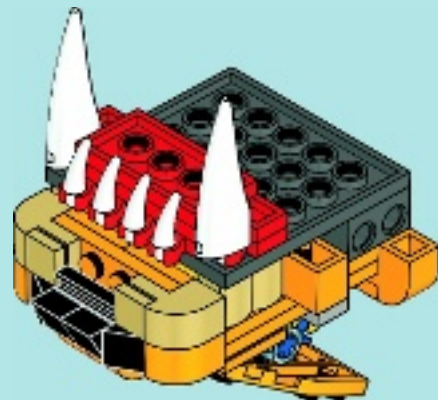

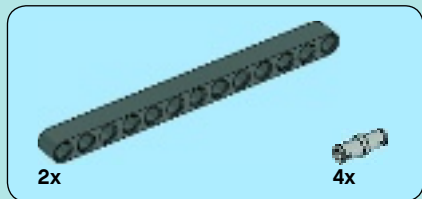

14

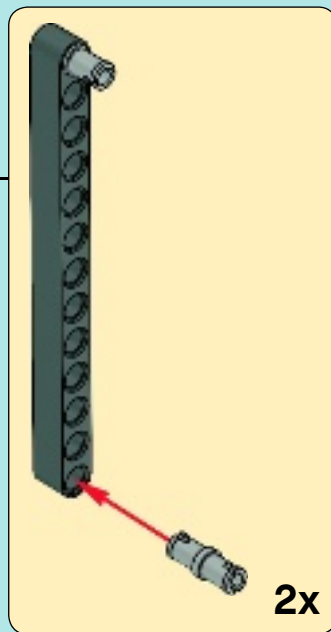
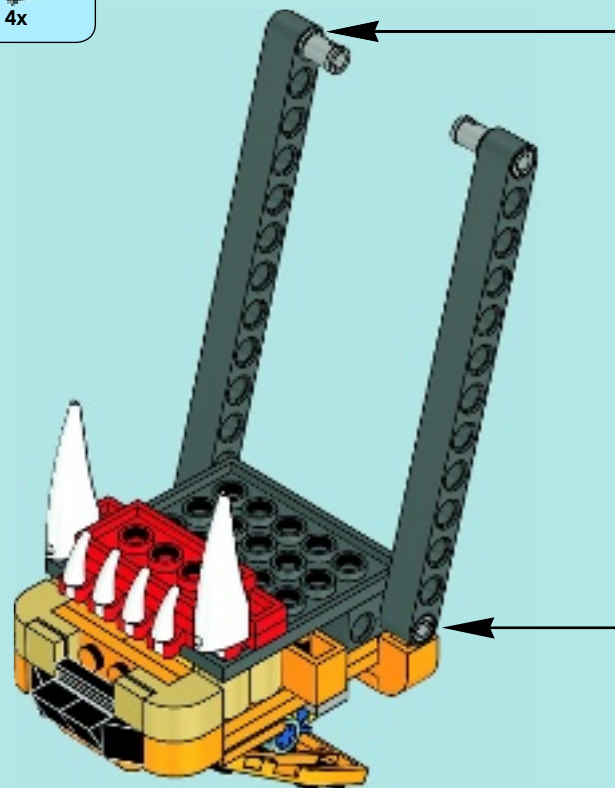

2x

15

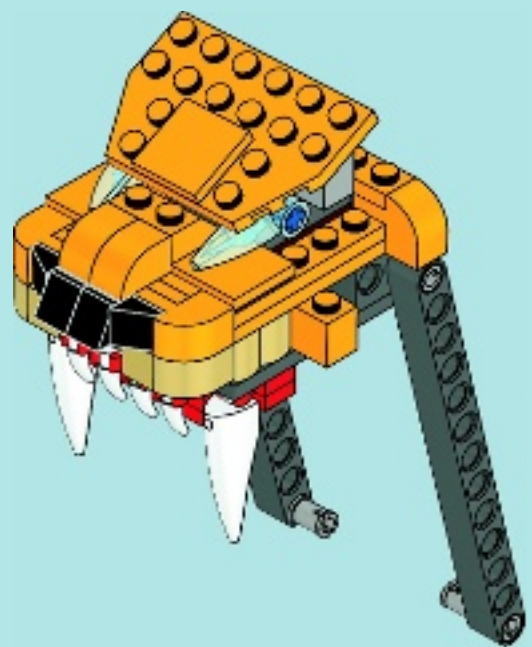
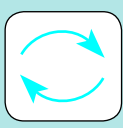

78

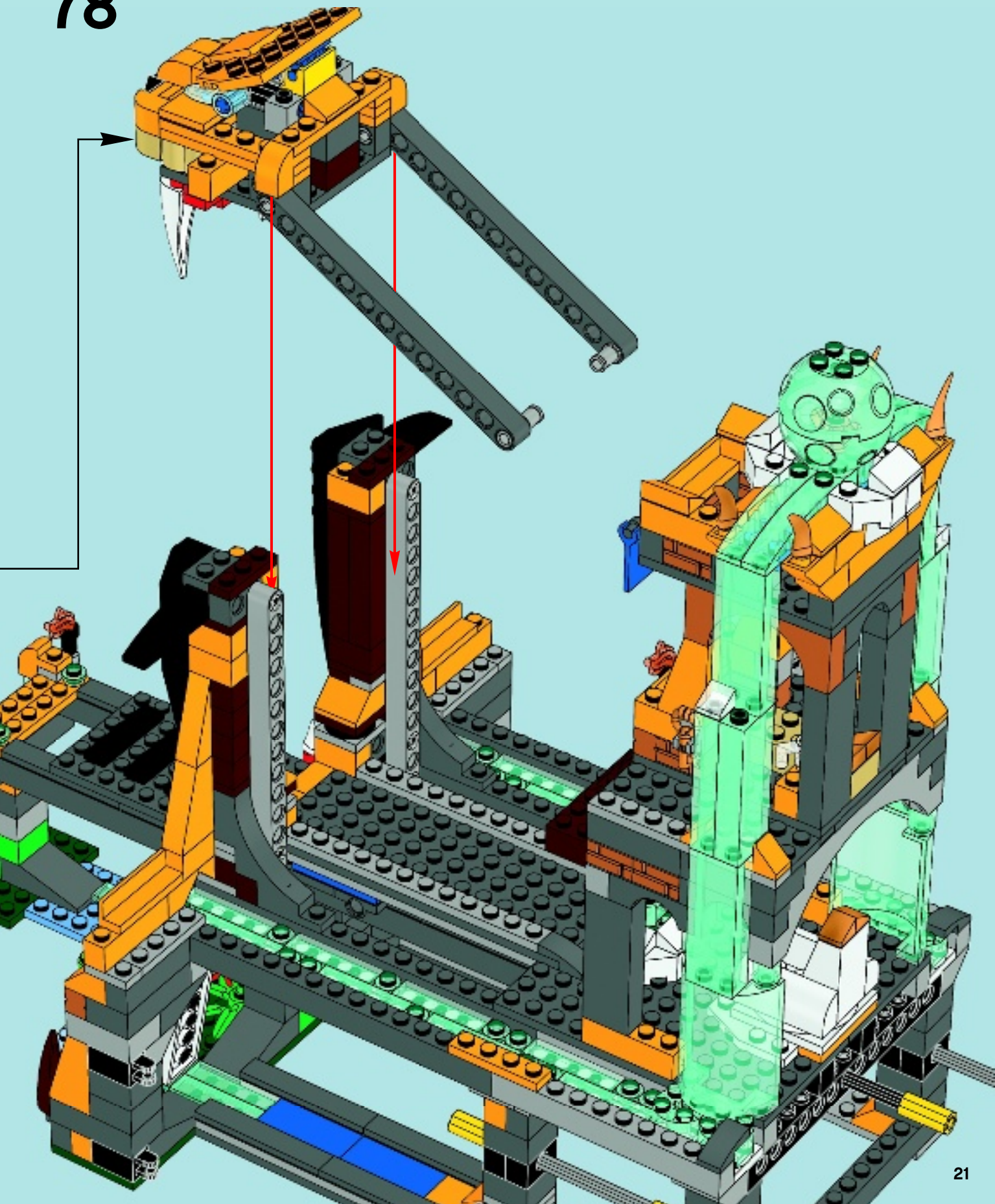

79

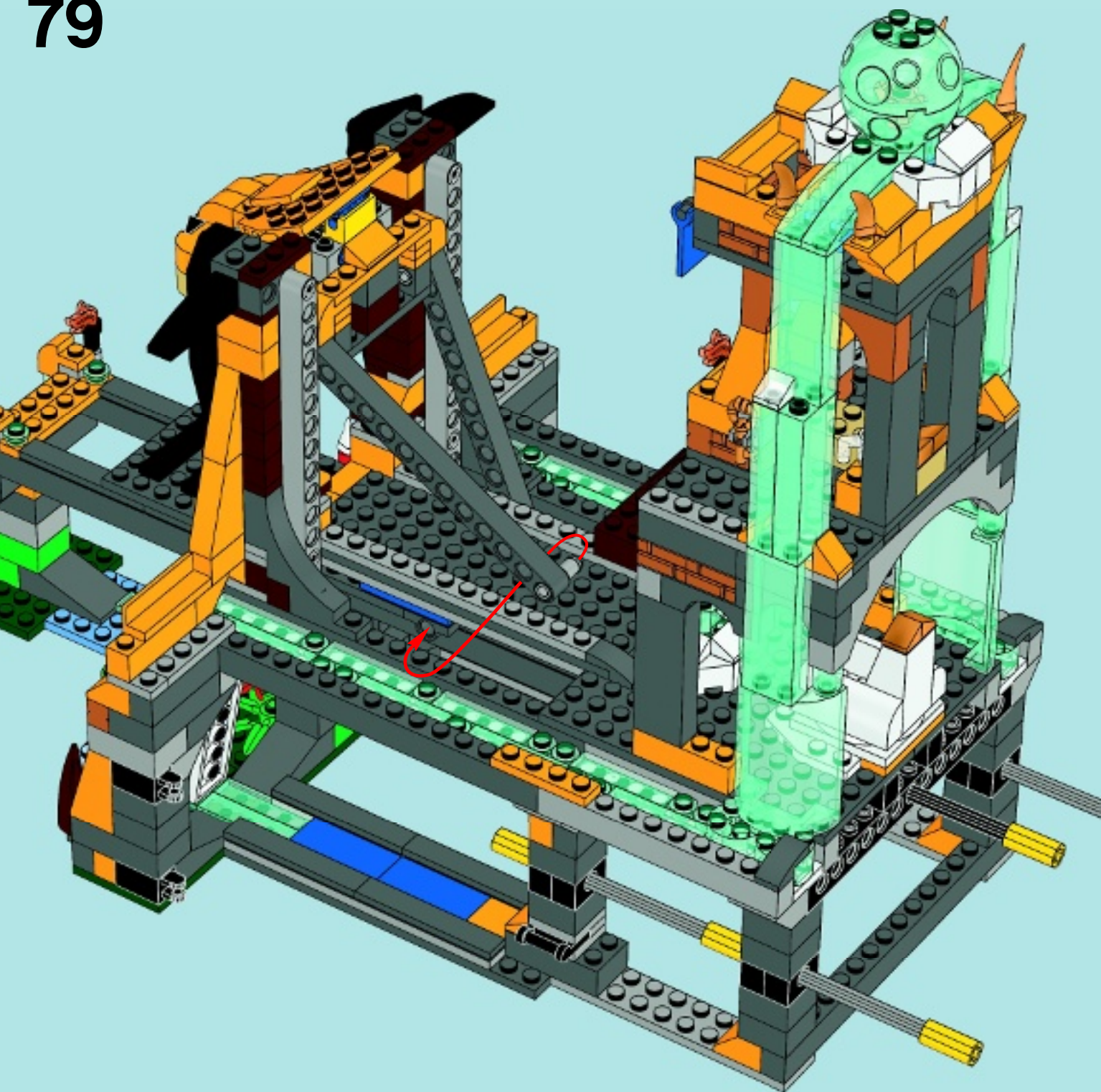

80

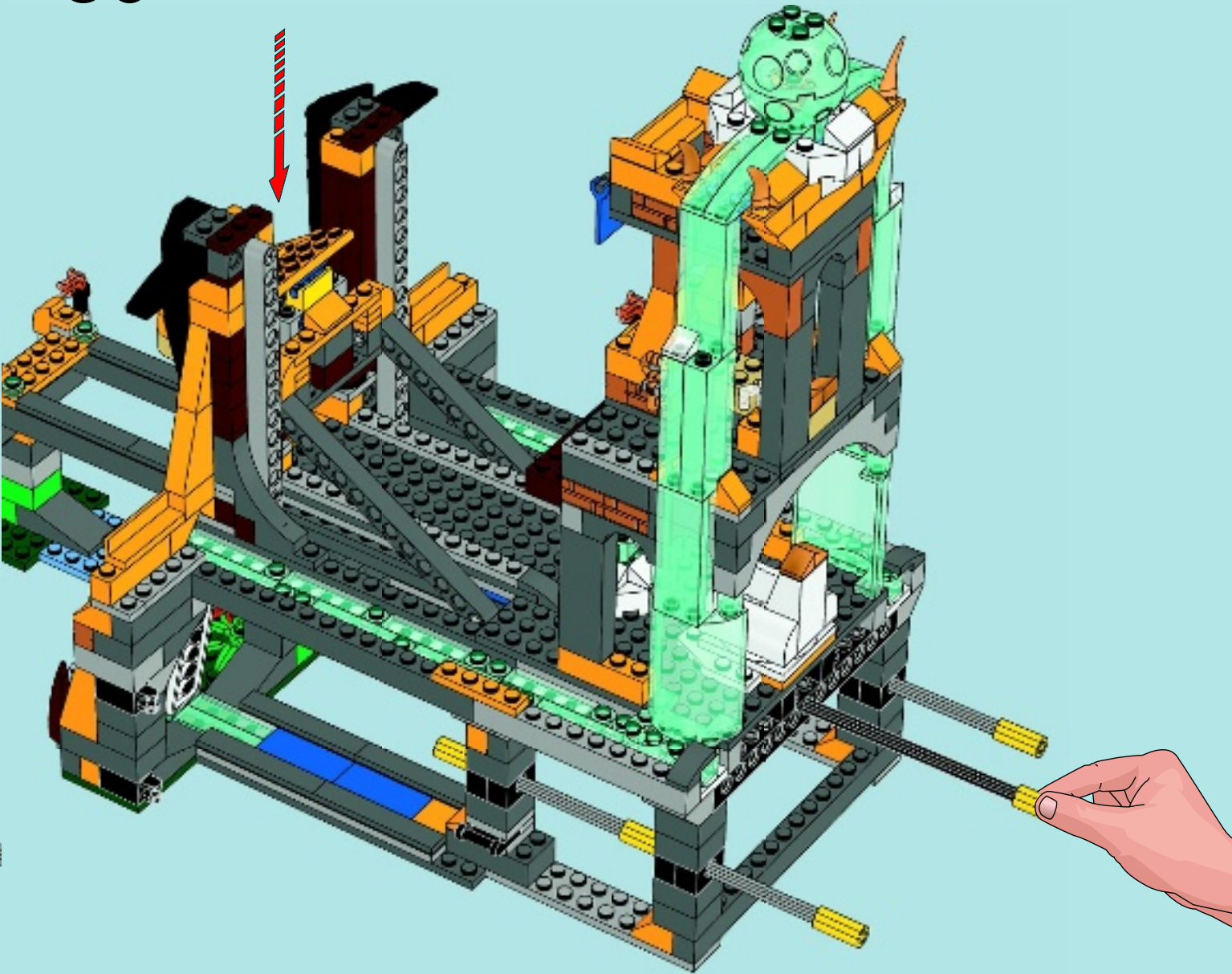

81

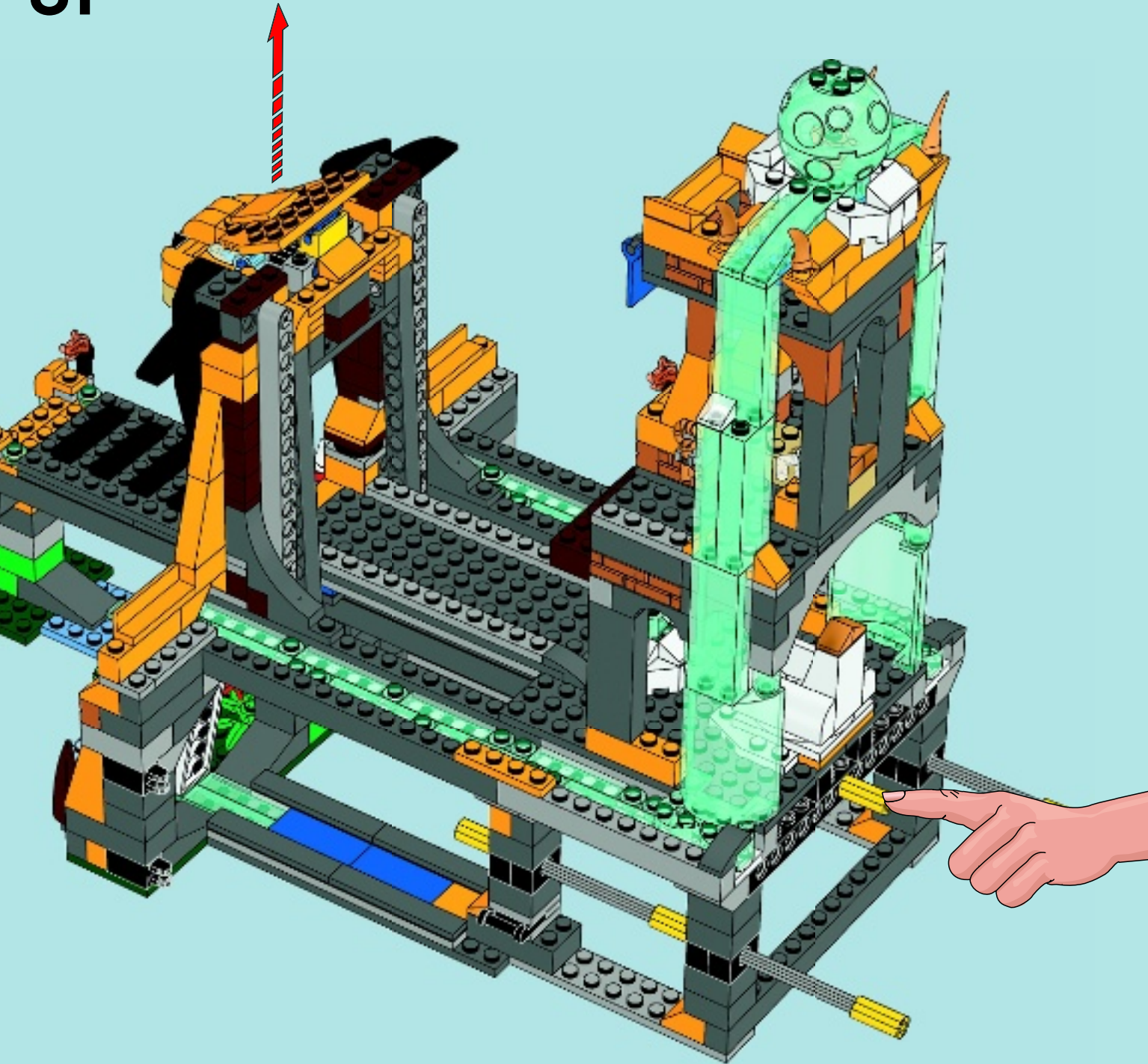



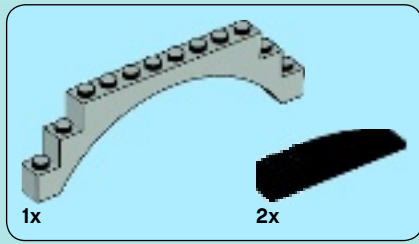

82

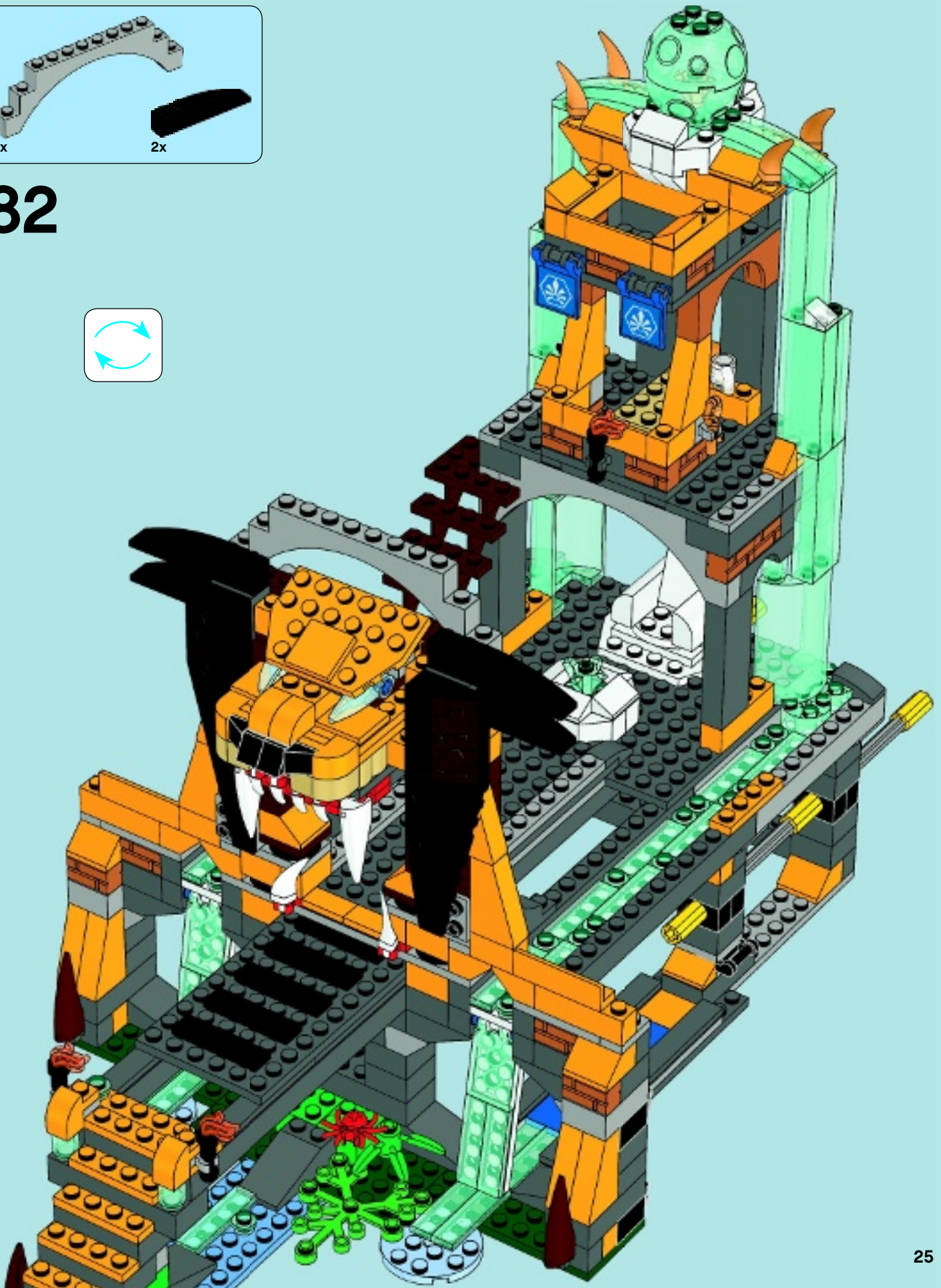



2x

# 83





2x



2x

# 84

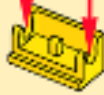

2x

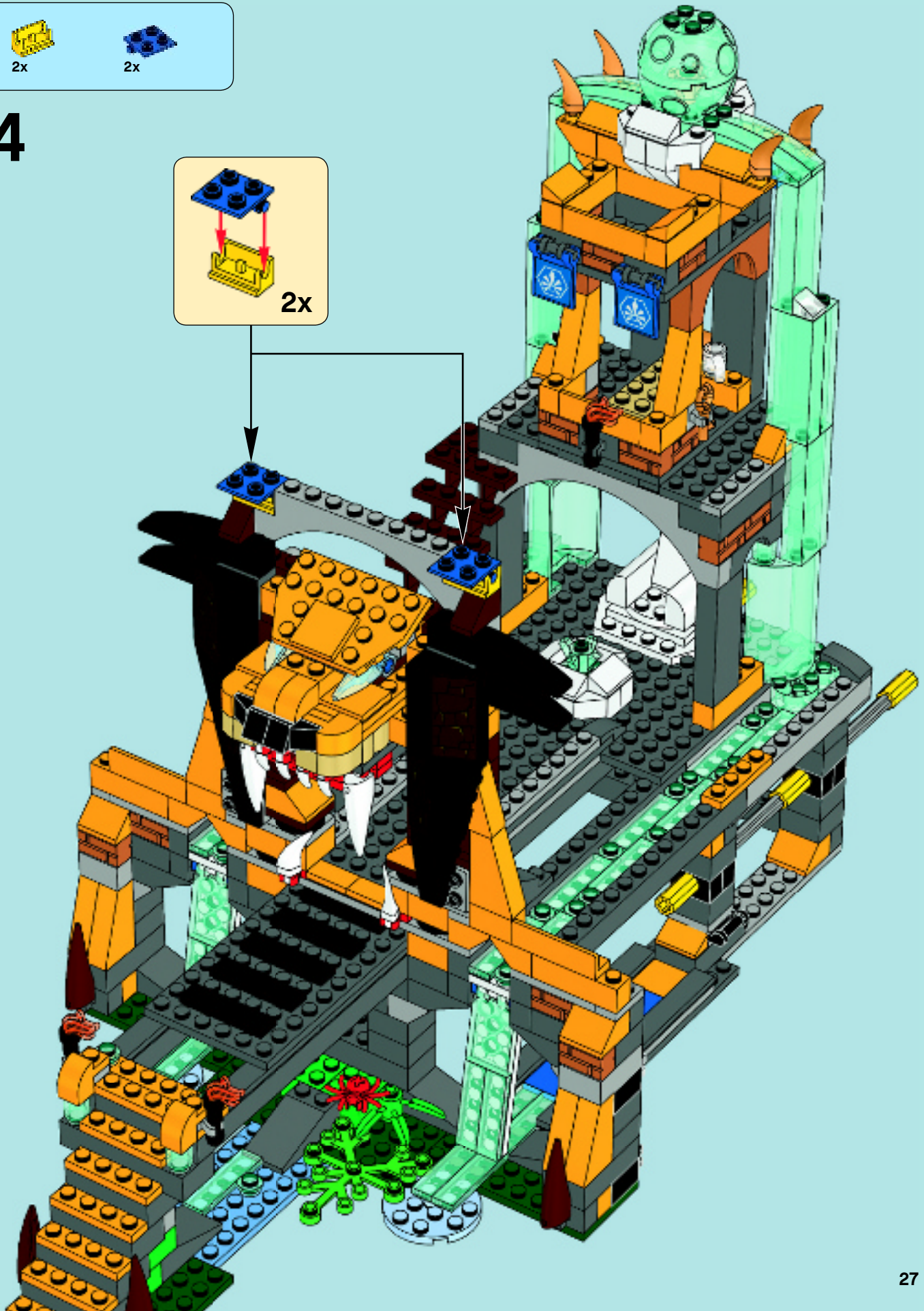

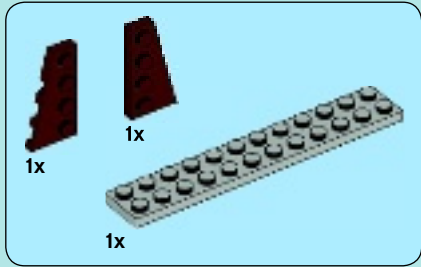

1

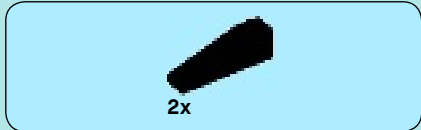
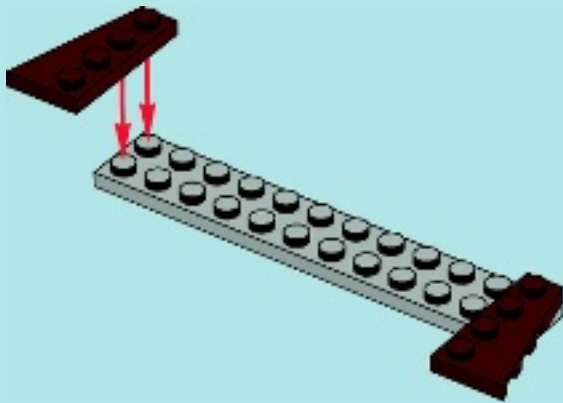

2

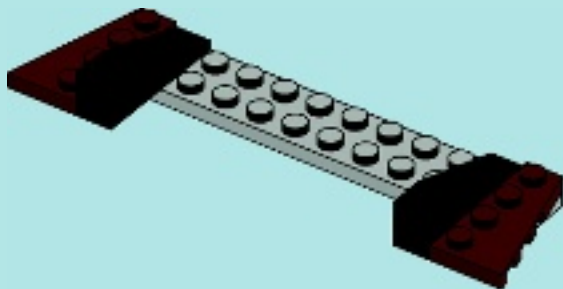

3

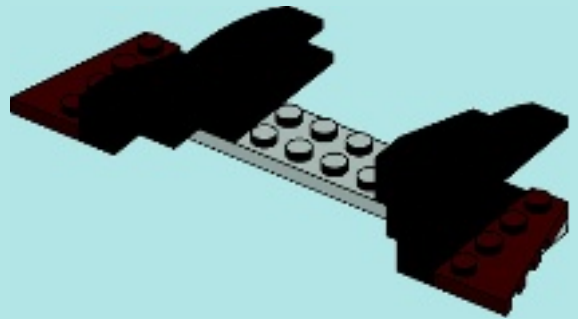

4

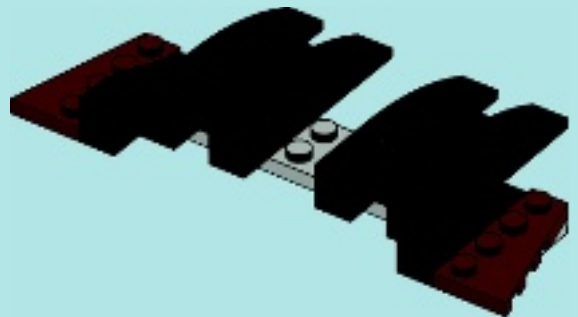

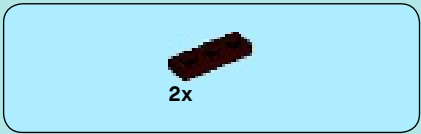

5

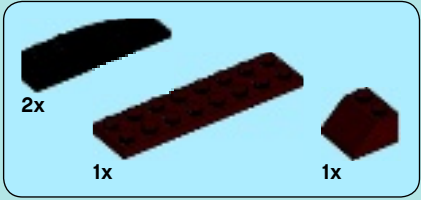
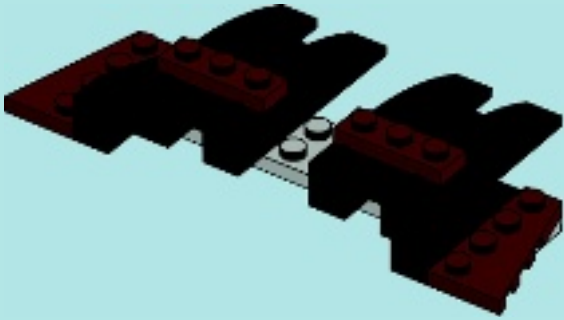

6

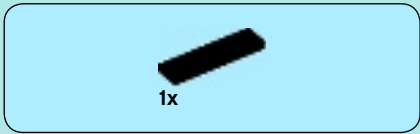
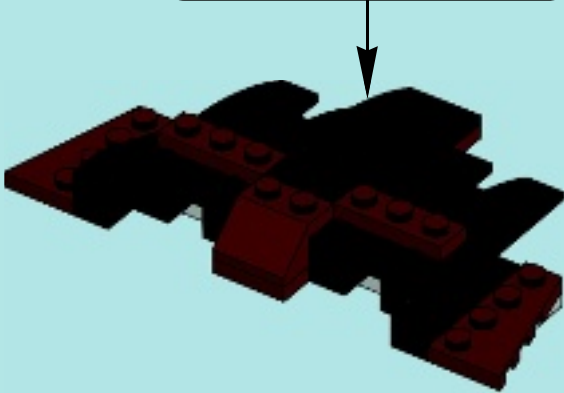
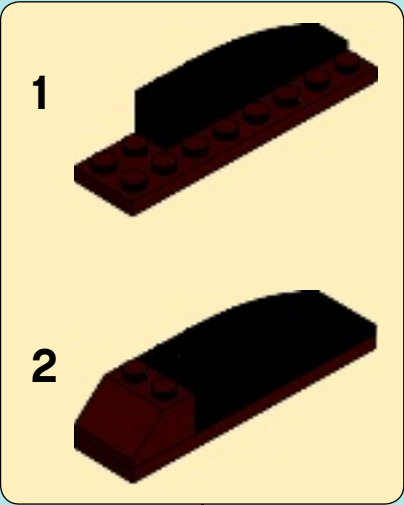

7

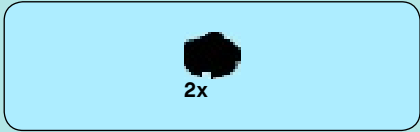
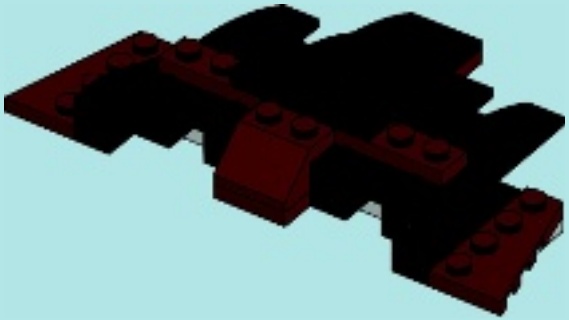

8

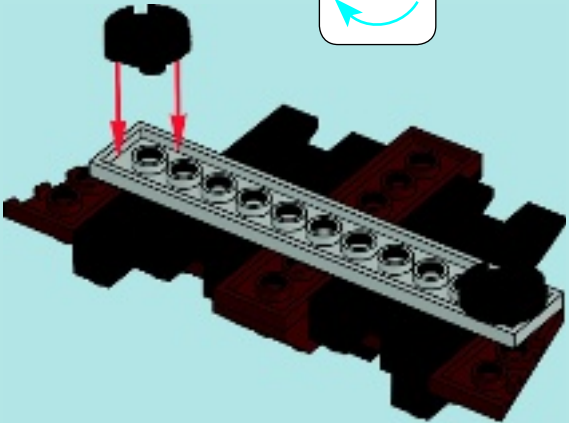
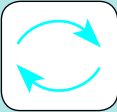

85



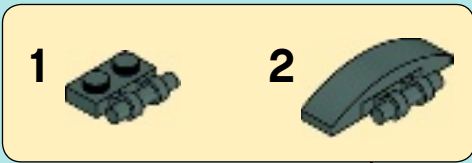

86

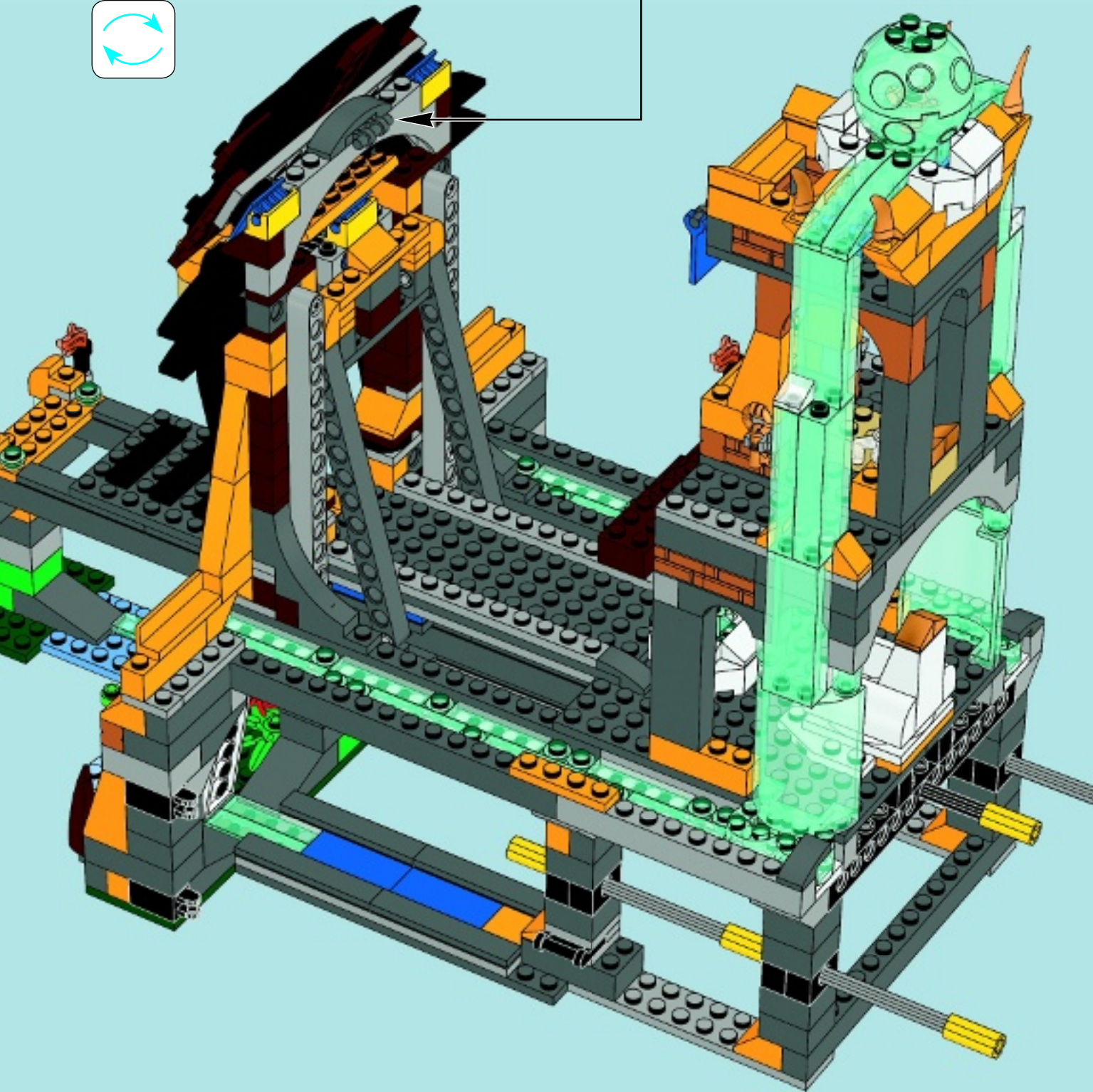



# 87

1



2

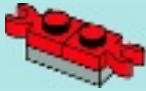

3



4



5



6

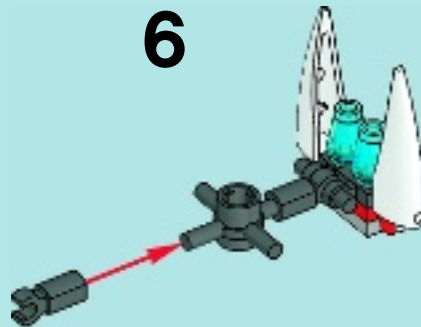



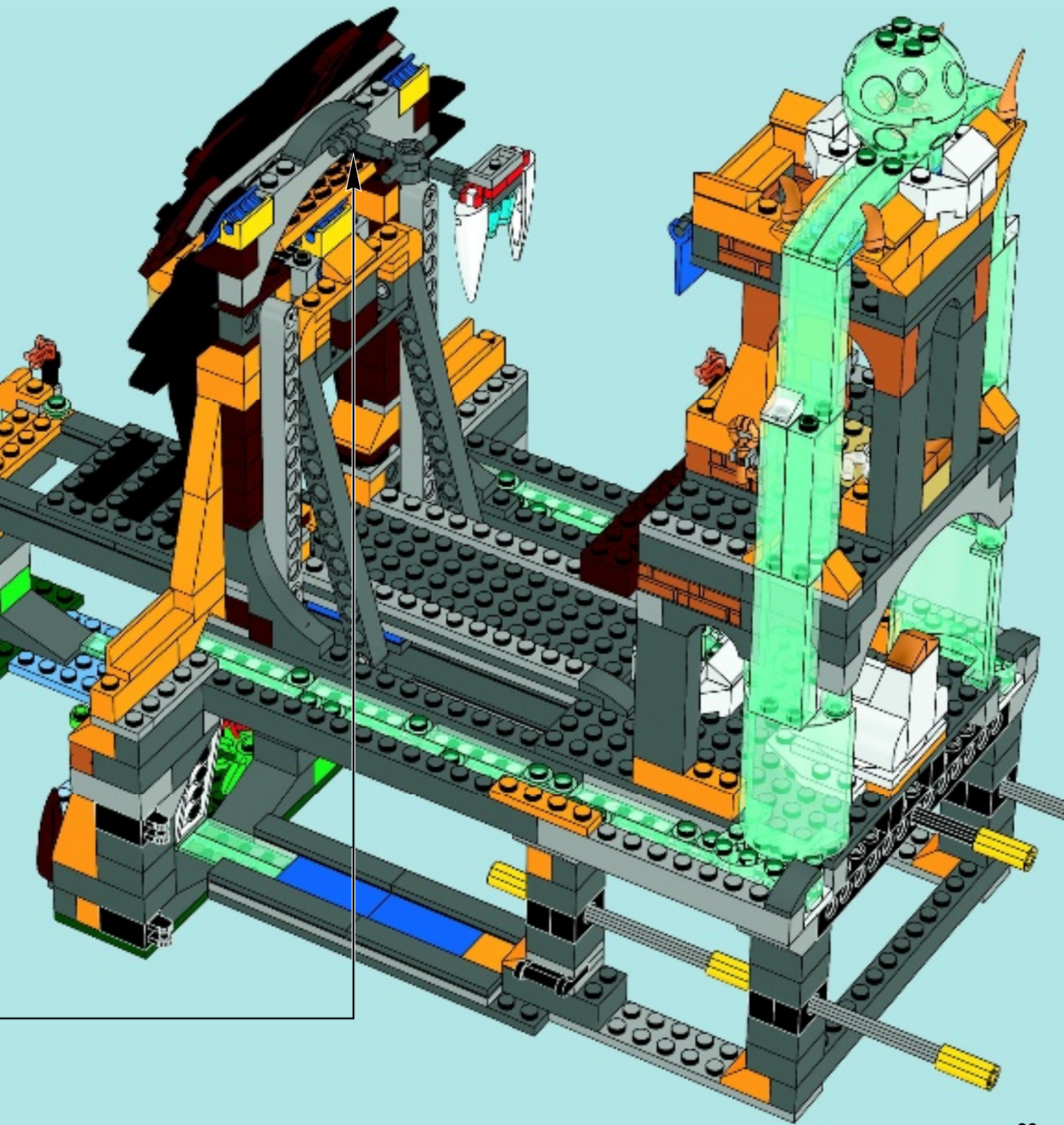

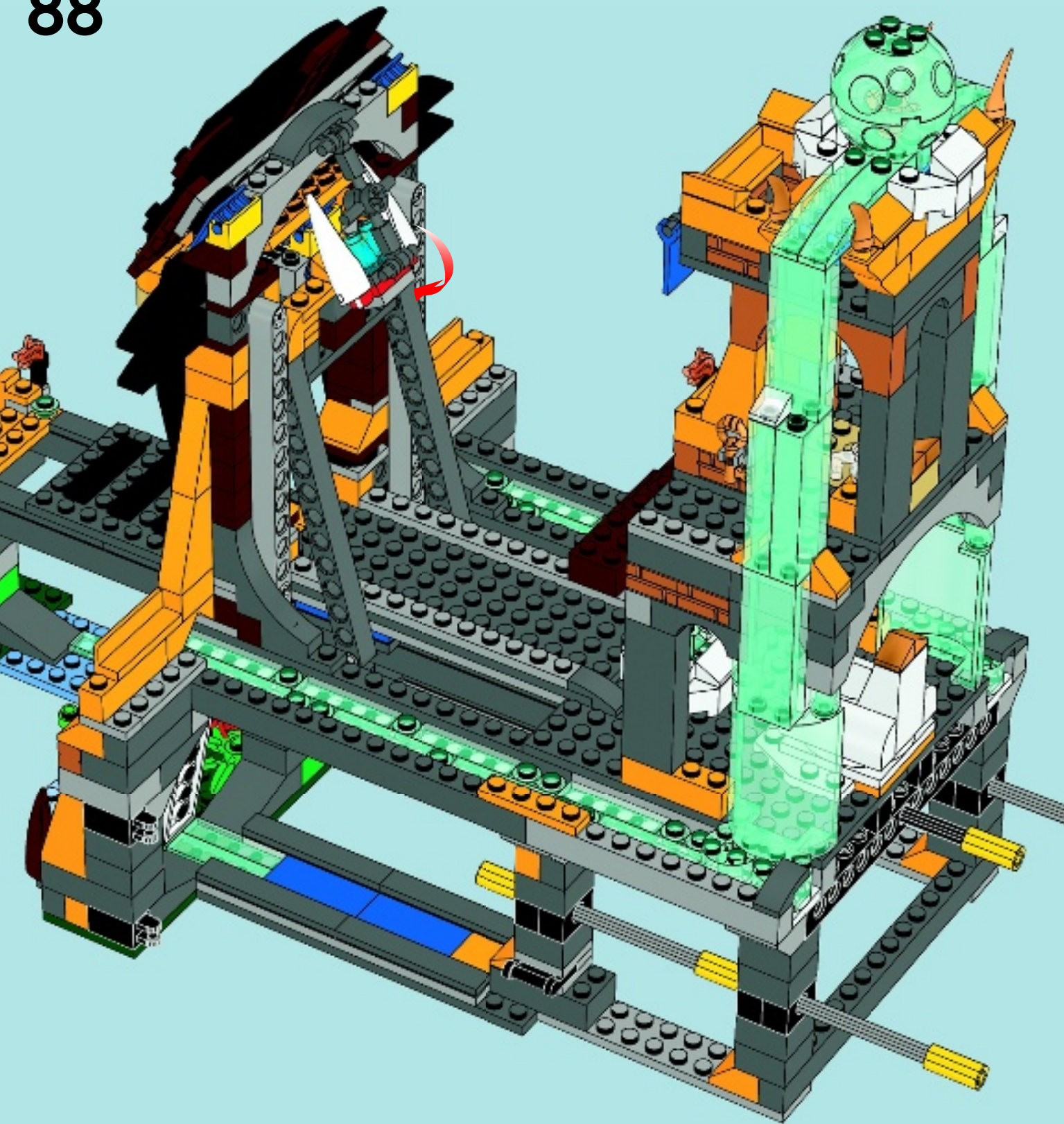

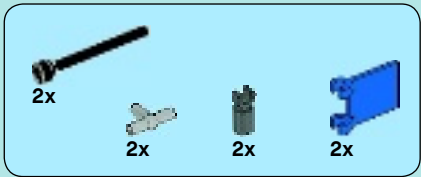
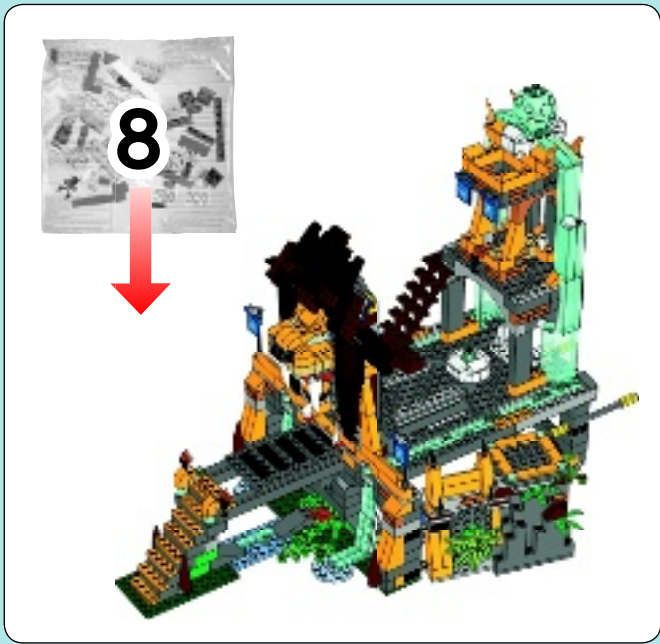

# 89

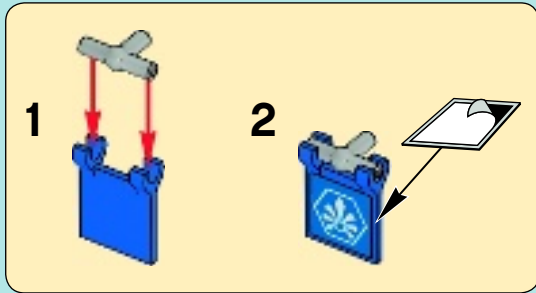

2x

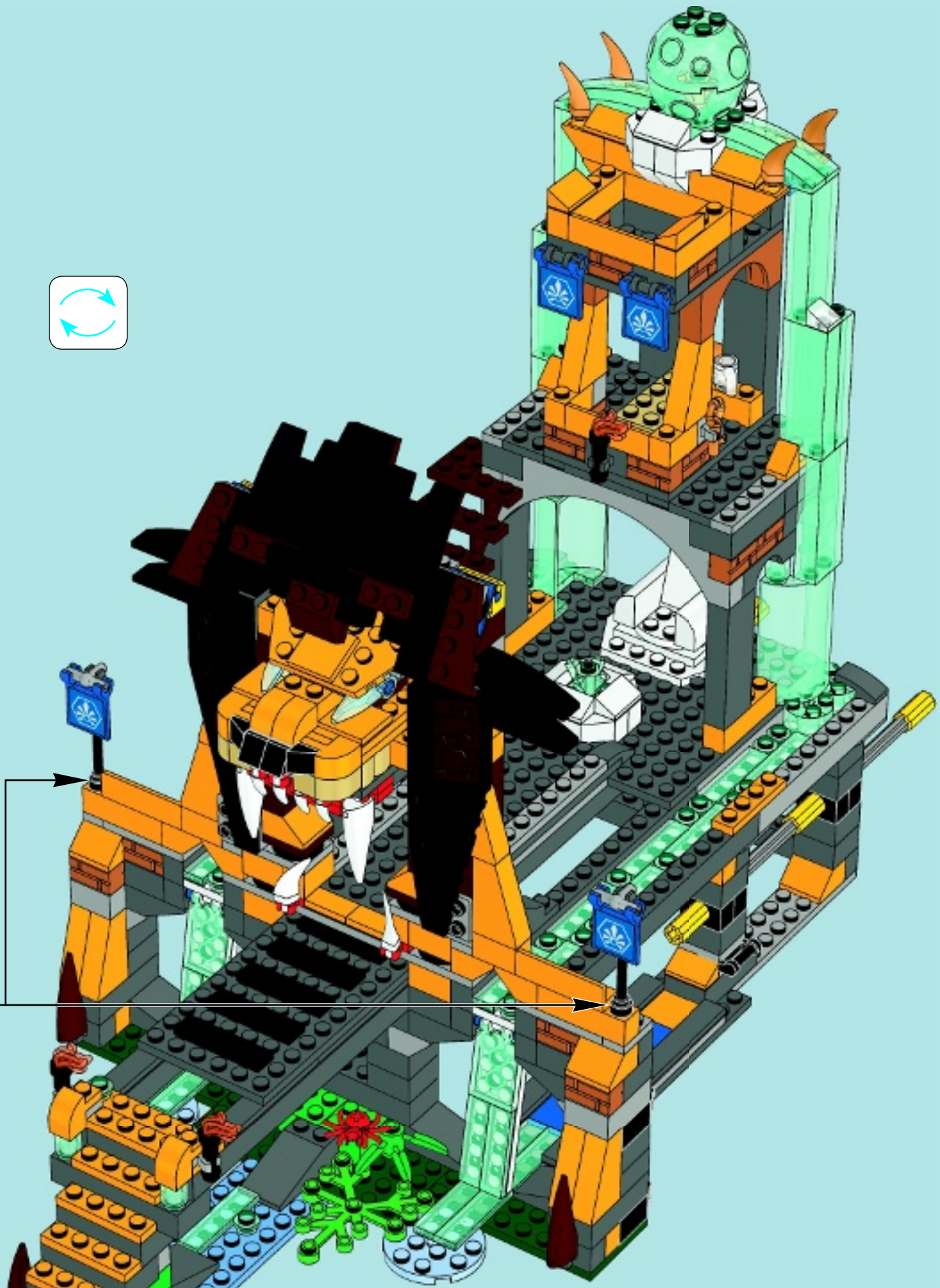

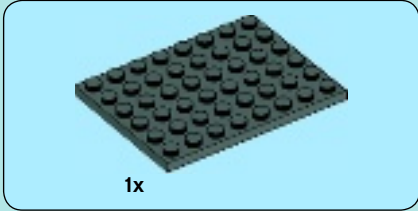
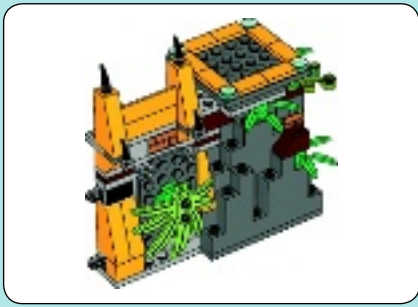

1

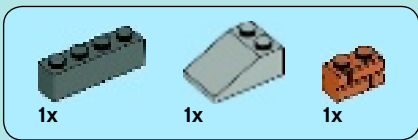

2

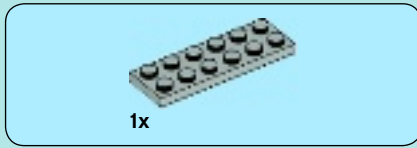
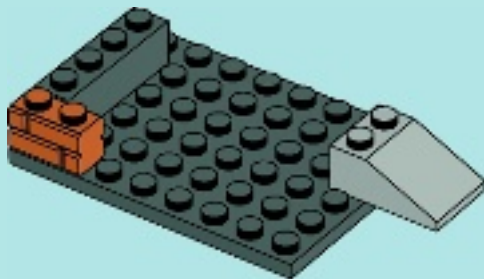

3

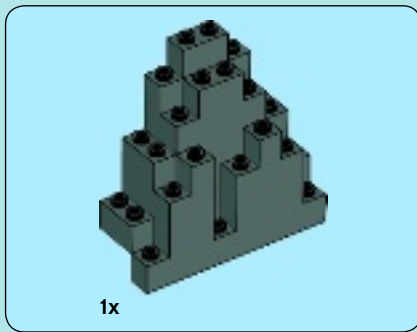
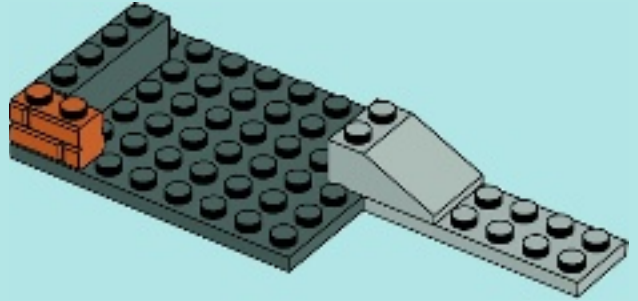

4

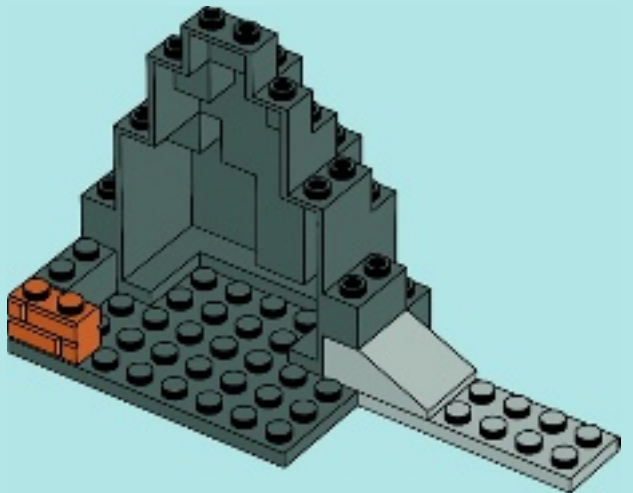

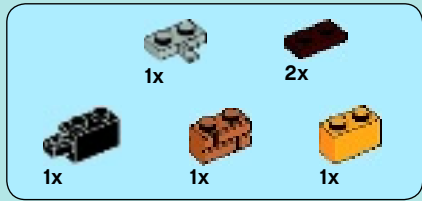

5

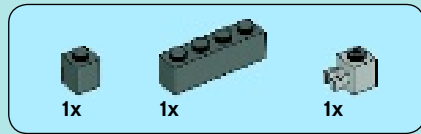
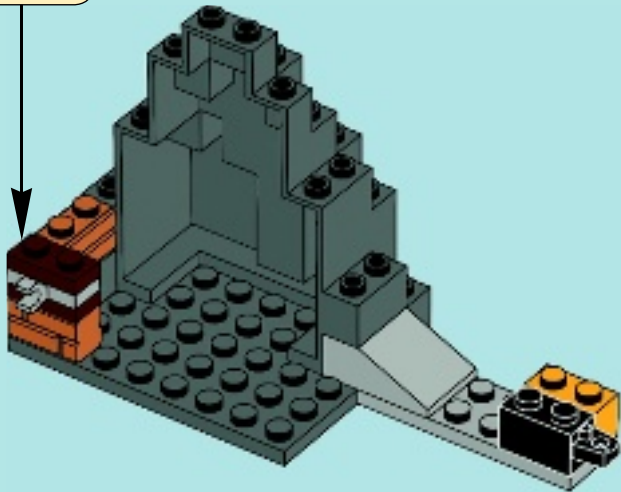
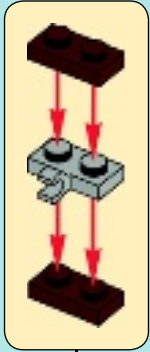

6

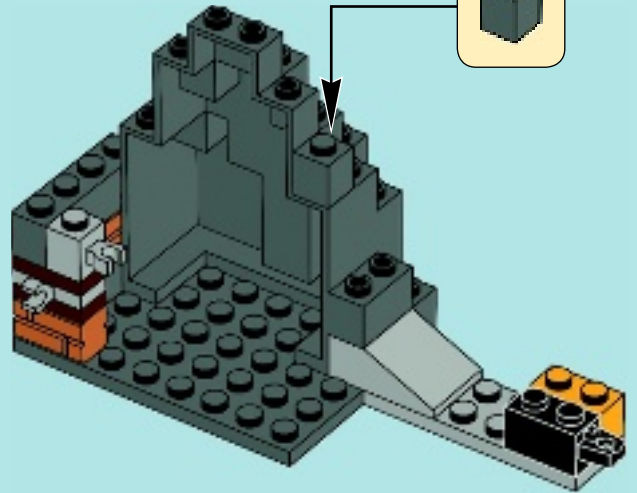
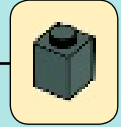

7

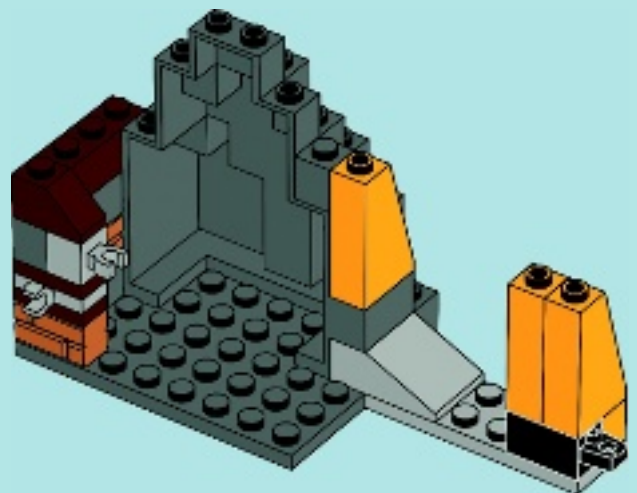

# LEGENDS OF CHIMA™

**WATCH THE VIDEO**

WATCH THE VIDEO · SÍGH DAP DAS VIDEO AN  
REGÁRDSE LA VÍDEO · MIRA EL VÍDEO  
VÉ O VÍDEO · MÓZZO MEO A VÍDEO!

**SCAN THE QR CODE**

SCAN THE QR CODE · SCANNE DEN QR-CODE  
SCANNILE QR CODE · CAPTURA EL CÓDIGO QR  
PÁZ SCAN DO CÓDIGO QR · OL VÍDEO ME A QR KÓDÓT



**LEGO.COM/CHIMA**





# LEGENDS OF CHIMA™

**LAGRAVIS**



70010 70108

**LAVAL**



70005  
70010 70115

**LONGTOOTH**



70005  
70010 70113

**LENNOX**



70002  
70006 70011  
70014 70104

**LEONIDAS**



70001 70006  
70014 70102

**FURTY**



70111

**SKINNET**



70107

**EWALO**



70010 70011

**ERIS**



70003  
70009 70114

**EQUILA**



70004  
70013 70101

**EGLOR**



70007  
70013 70105

**EWAR**



70012

**GRUMLO**



70008

**G'LDUNA**



70008

**GURZAN**



70008 70109

**GRIZZAM**



70009 70110



**CROMINUS**



70006  
70014 70103

**CRAGGER**



70006 70010  
70014 70115

**CROOLER**



70006

**CRUG**



70002  
70014 70112

**CRAWLEY**



70001  
70005 70010

**RAWZOM**



70006 70114

**RAZAR**



70003 70010  
70012 70100

**RIZZO**



70003  
70008 70012

**RAZCAL**



70000 70007

**WORRIZ**



70009 70011

**WAKZ**



70004  
70009 70113

**WILHURT**



70009 70013

**WINDRA**



70009

**WINZAR**



70004 70106



LEGENDS OF  
**CHIMA**<sup>TM</sup>



**WATCH THE MODEL  
IN ACTION**

ERLEBE DAS MODELL IN AKTION  
REGARDE LA DÉMO DU MODÈLE EN ACTION  
MIRA EL MODELO EN ACCIÓN  
VÉ O MODELO EM AÇÃO  
NÉZD MEG A MODELLT MŰKÖDÉS KÖZBEN

**SCAN THE QR CODE**

SCANNE DEN QR-CODE  
SCANNE LE QR CODE  
CAPTURA EL CÓDIGO QR  
FAZ SCAN DO CÓDIGO QR  
OLVASD BE A QR KÓDOT



[LEGO.COM/CHIMA](http://LEGO.COM/CHIMA)

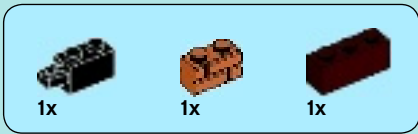

8

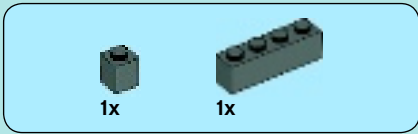
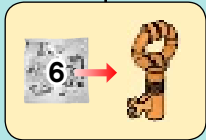
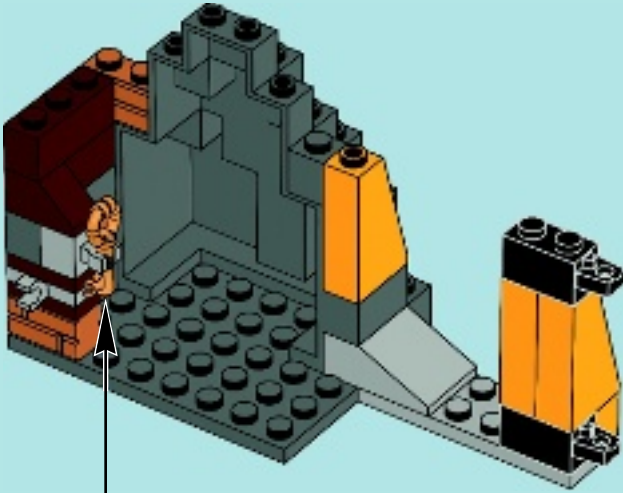

9

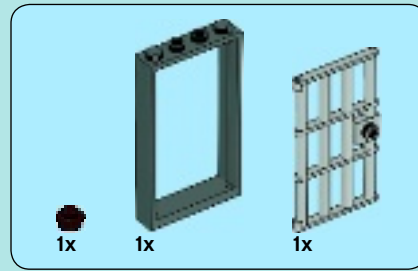
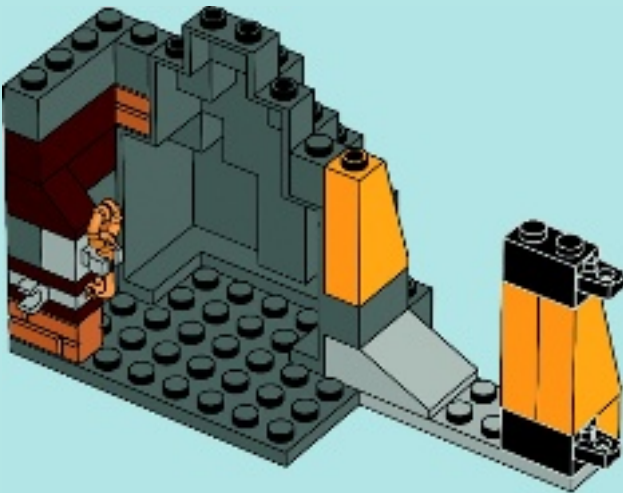

10

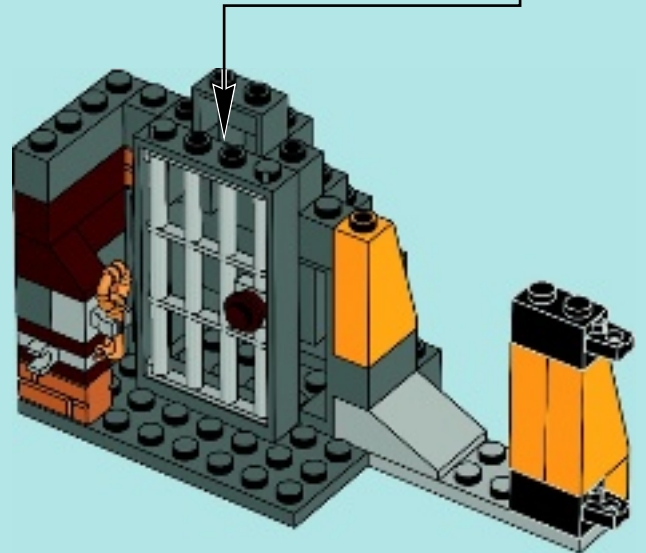
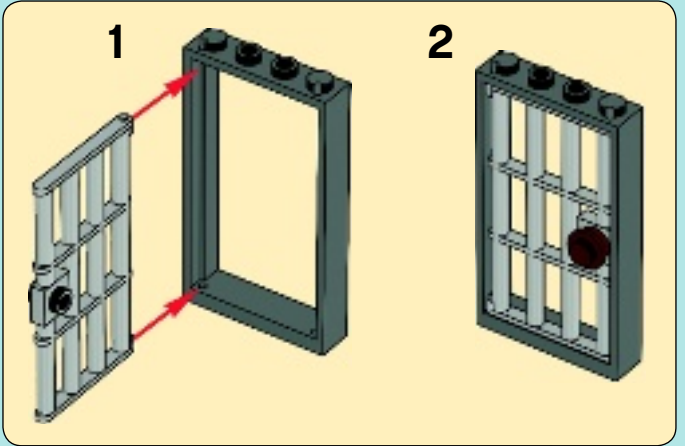

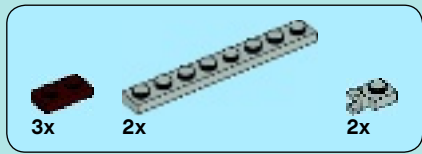

# 11

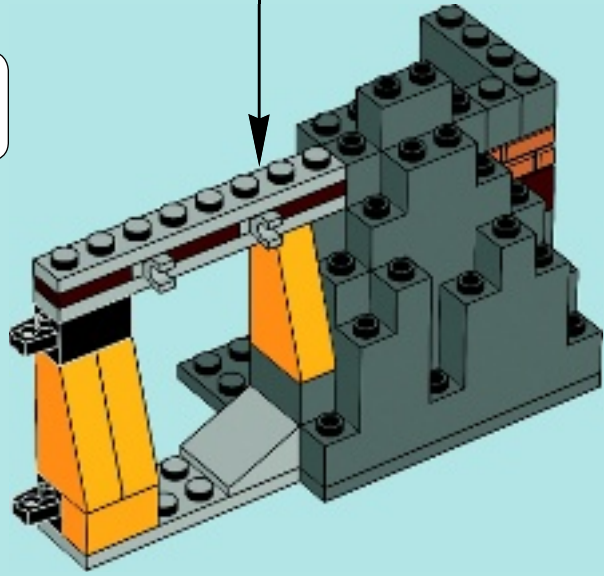
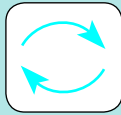
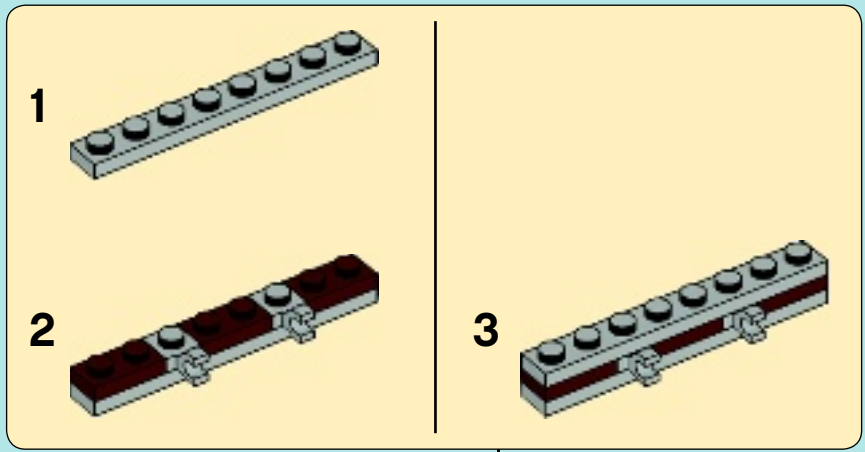

# 12

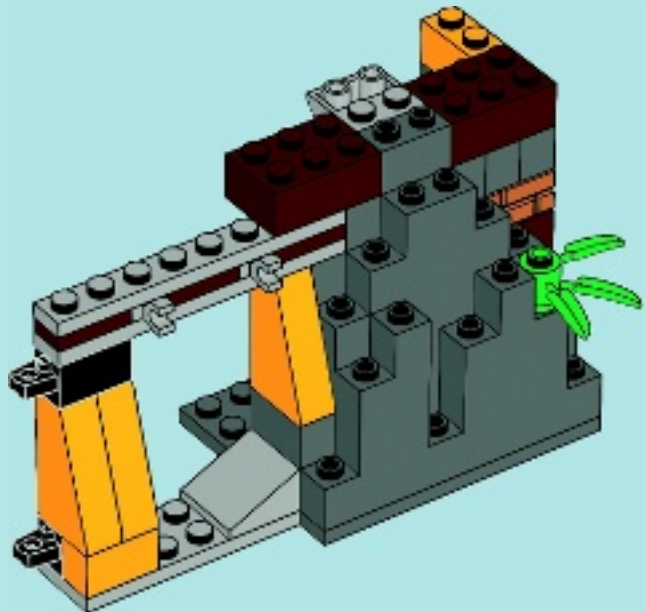



13

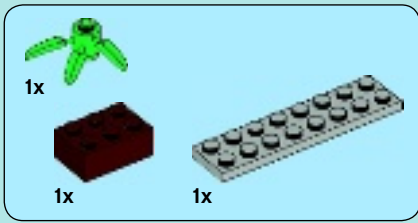
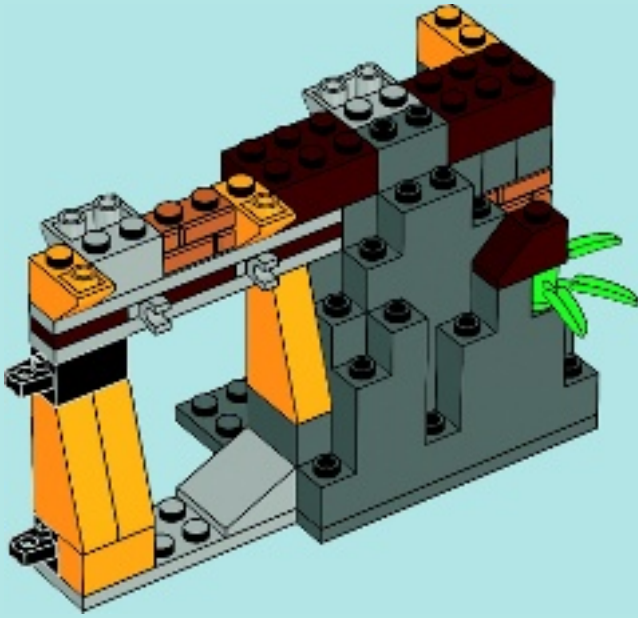

14

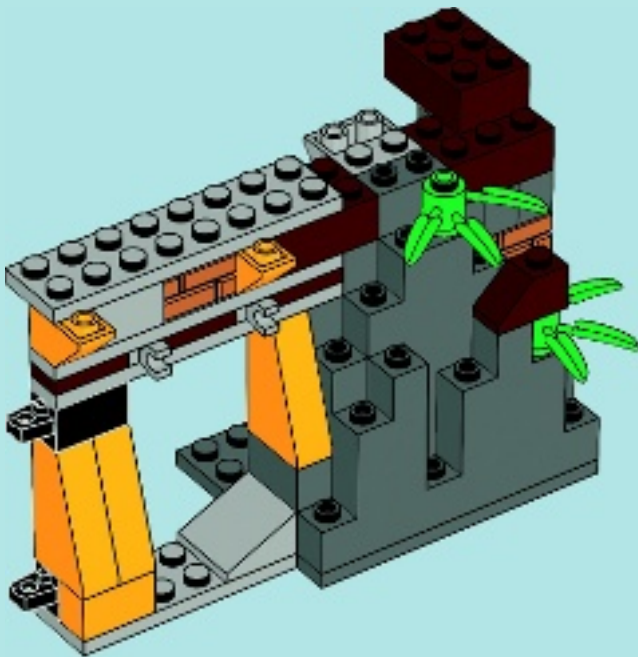

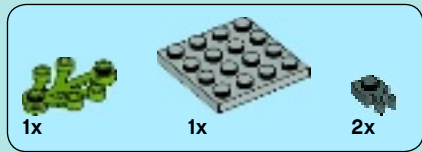

15

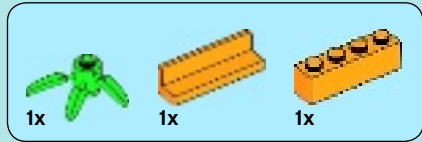
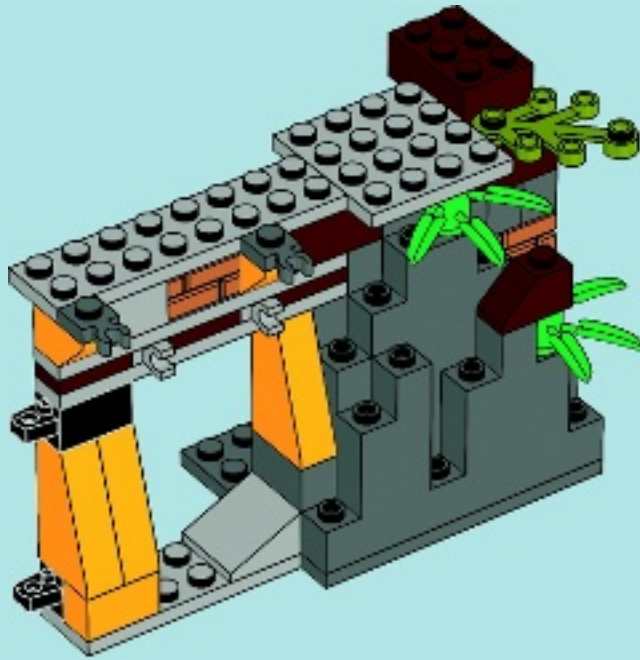

16

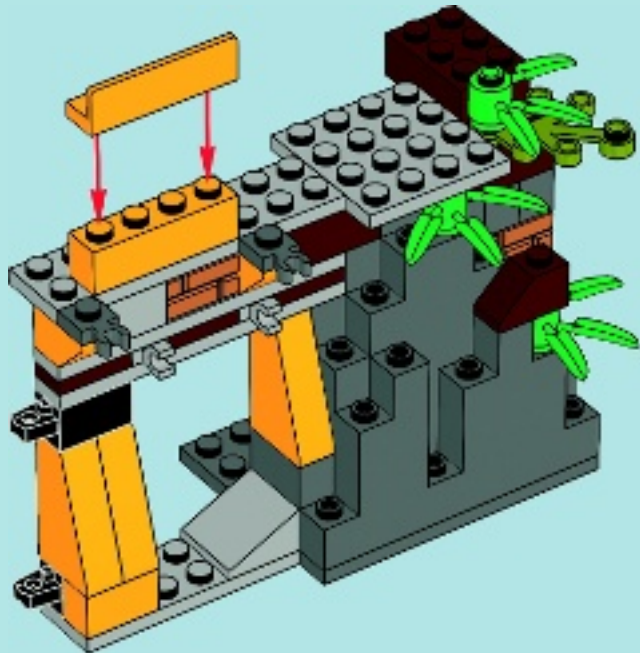

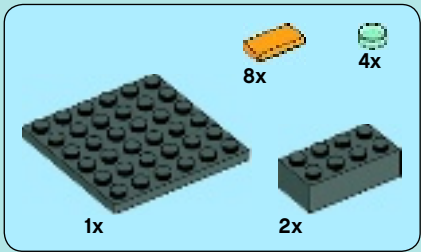

# 17

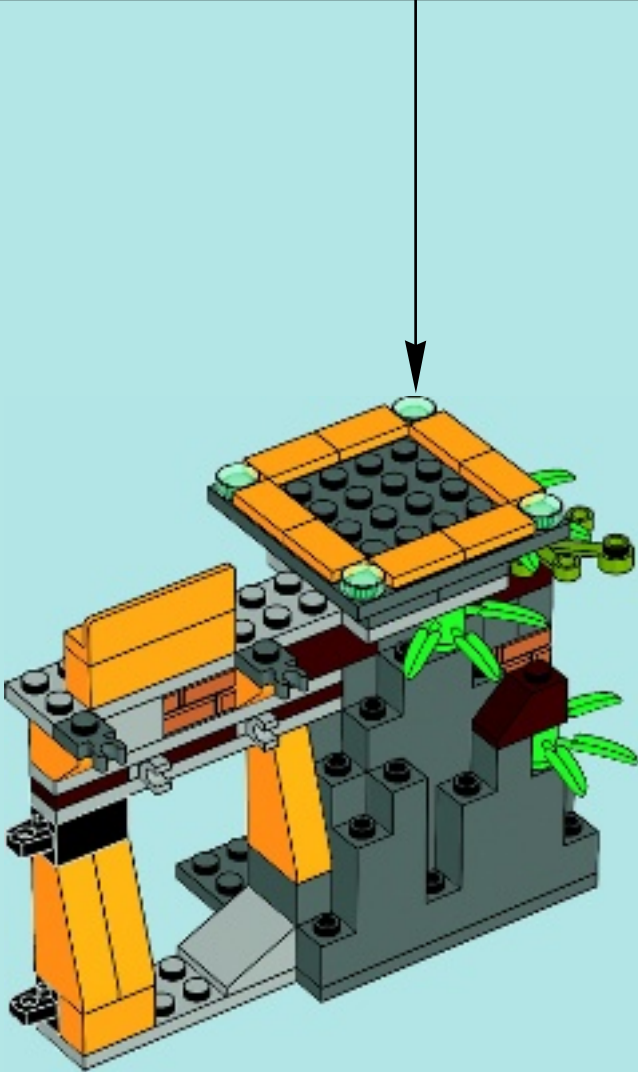
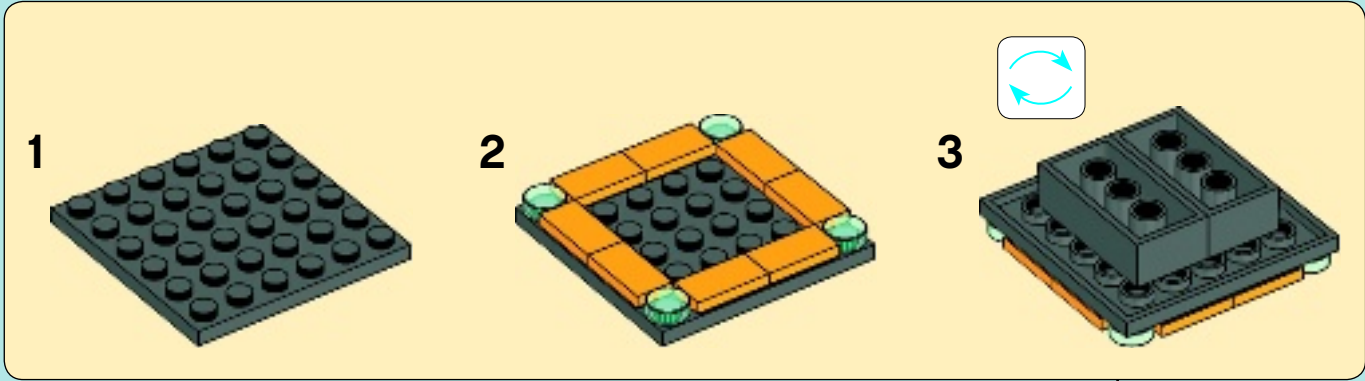



2x

18

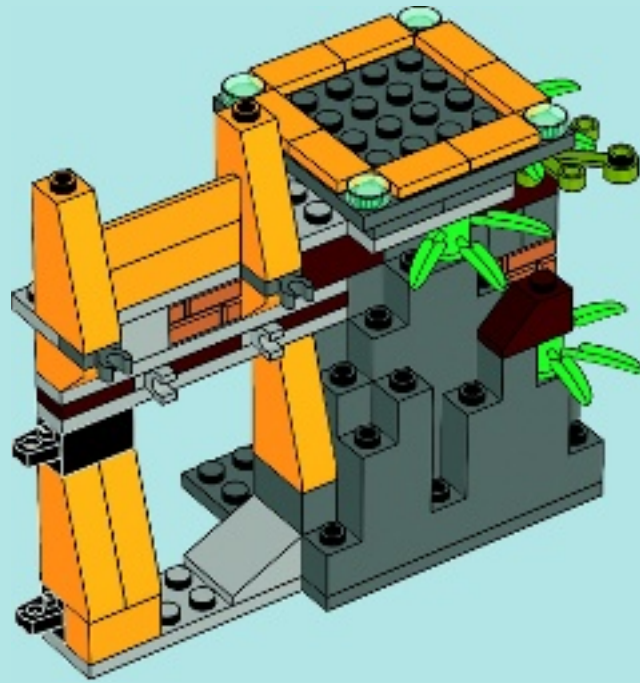

4x

19

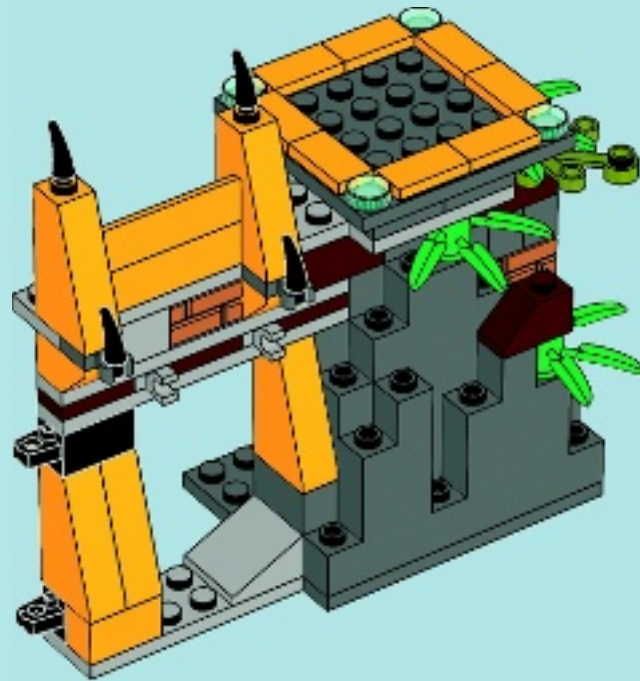



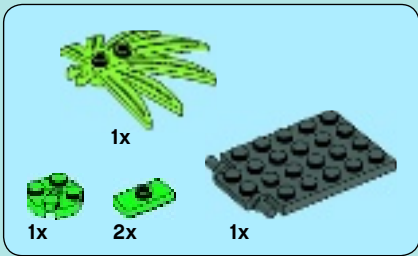

# 20

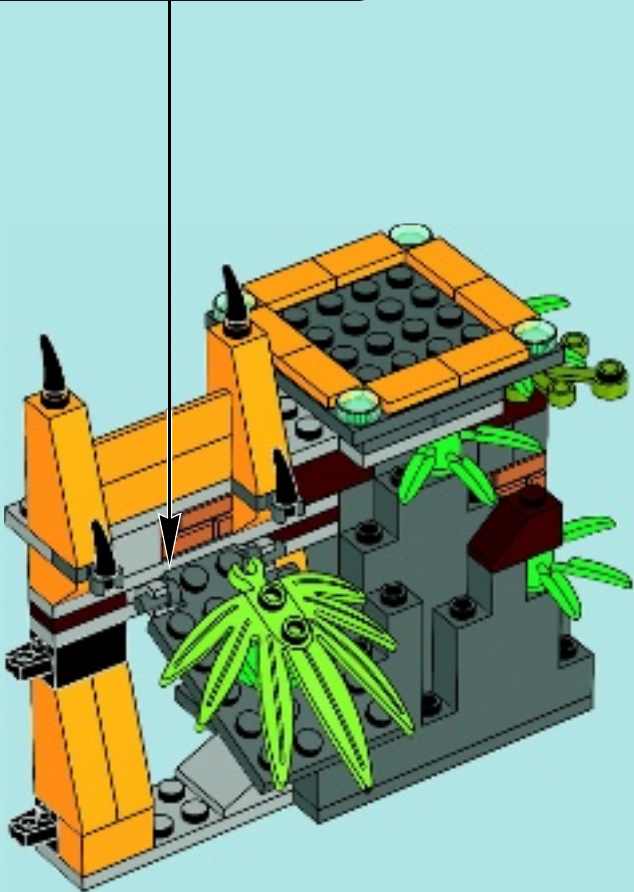
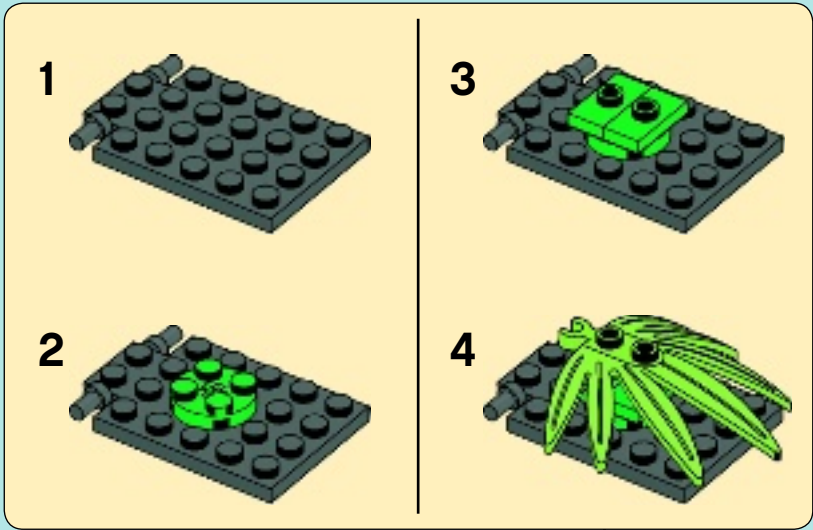

90

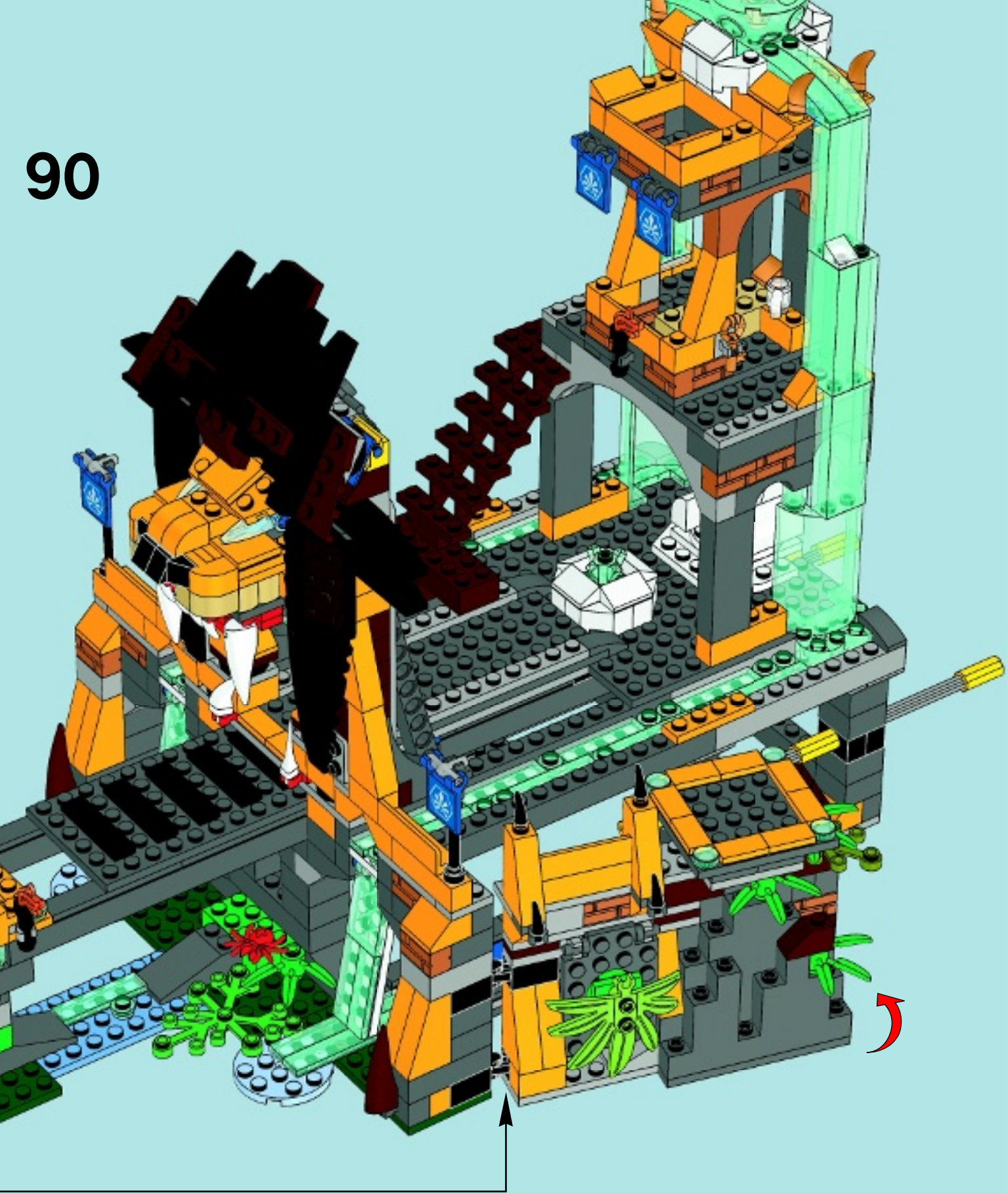

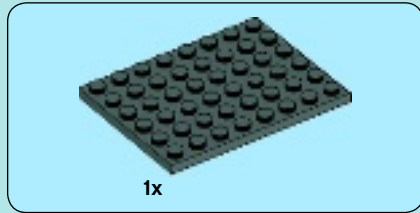
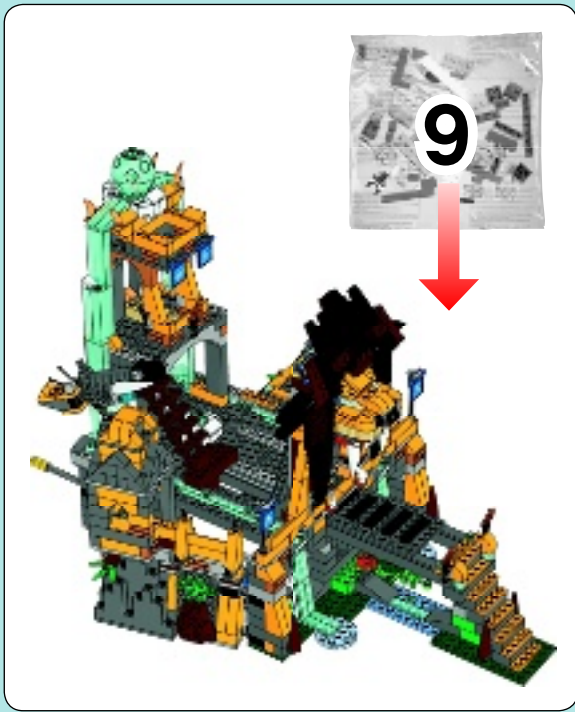

1

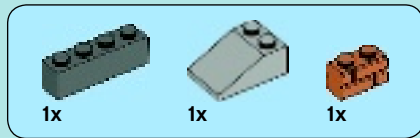

2

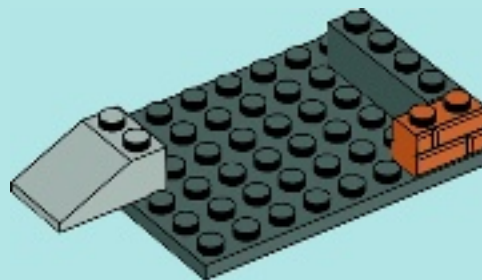

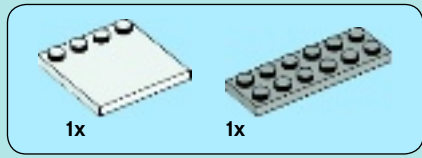

3

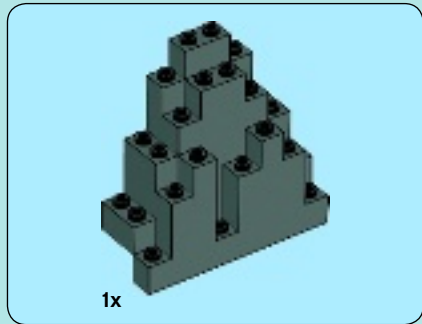
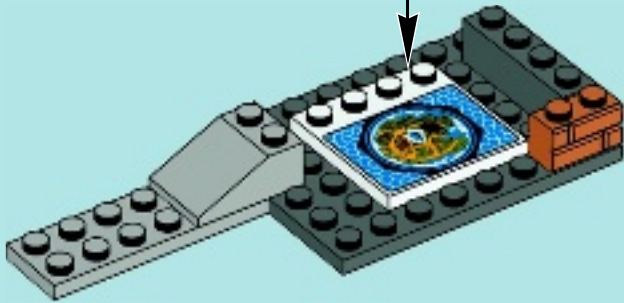
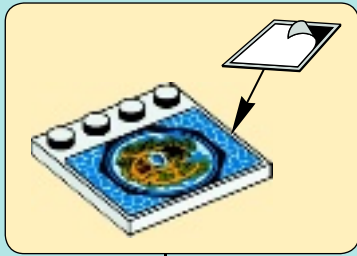

4

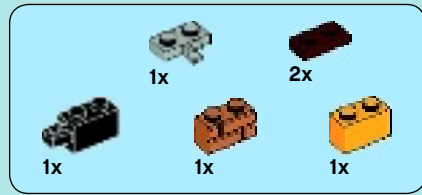
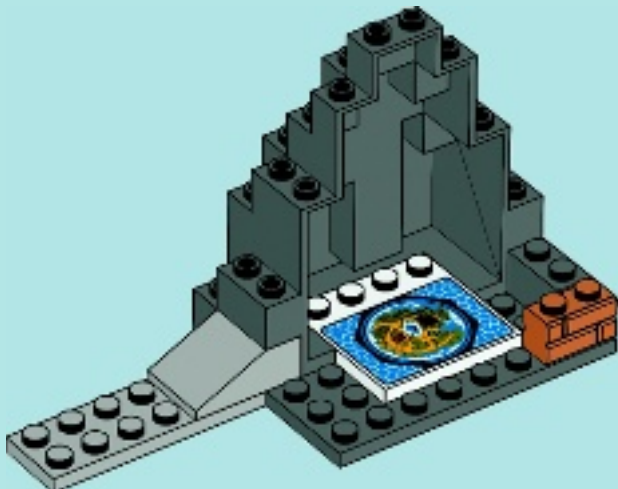

5

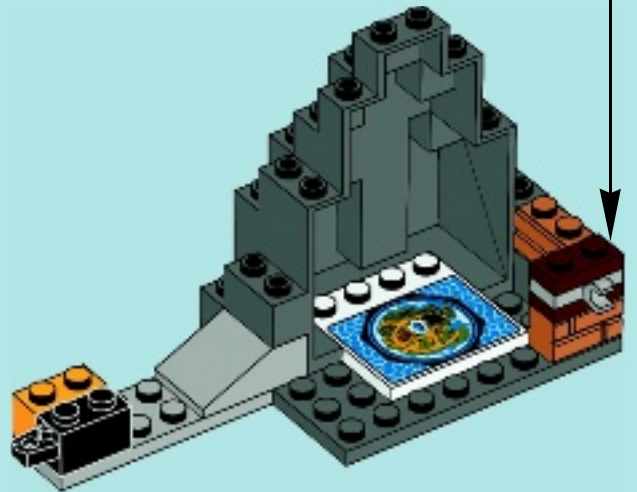
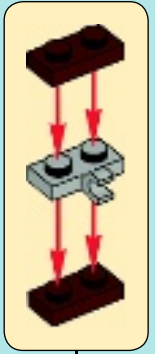

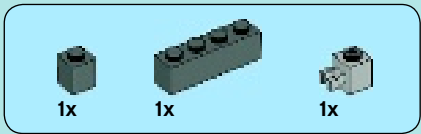

6

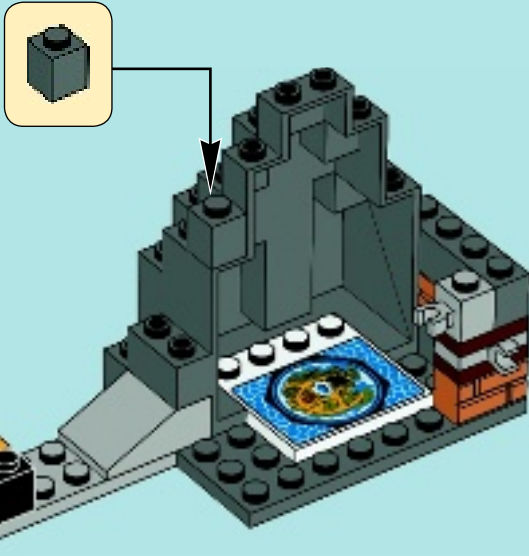

7

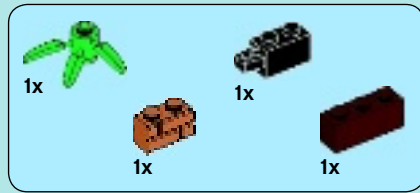
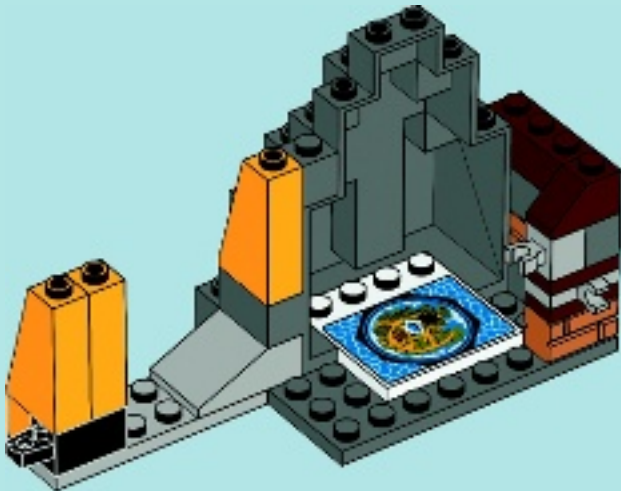

8

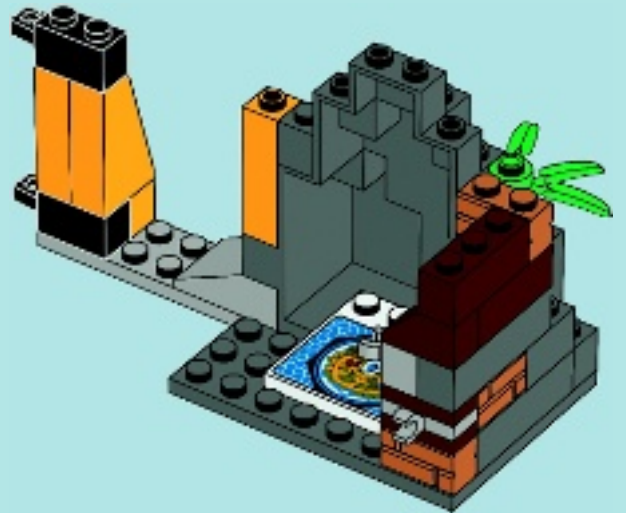
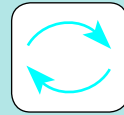

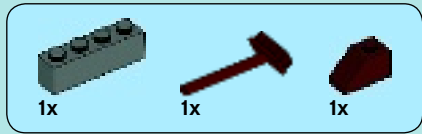

9

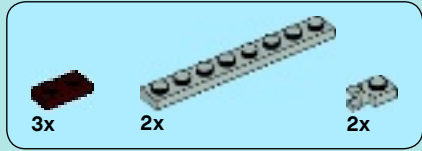
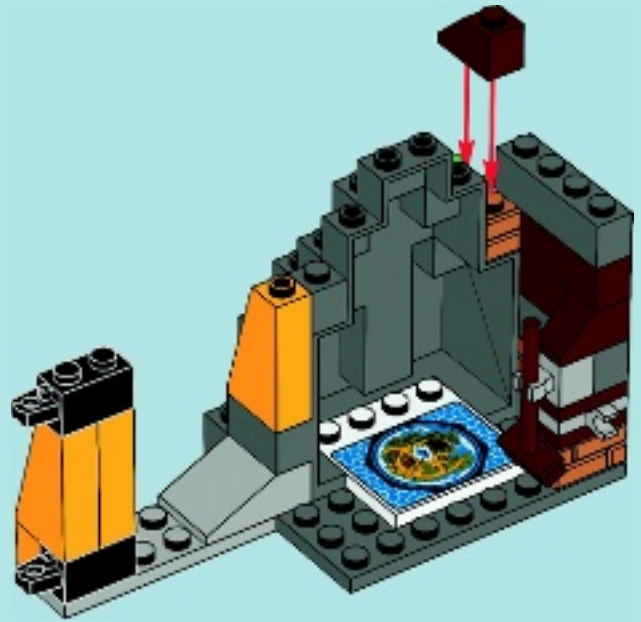
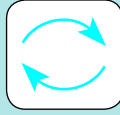

10

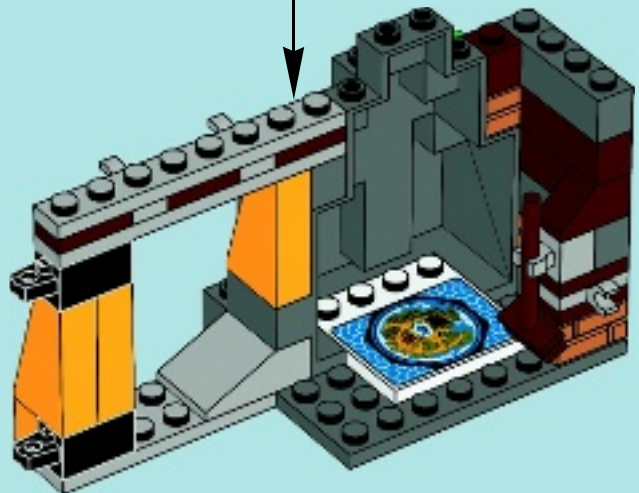
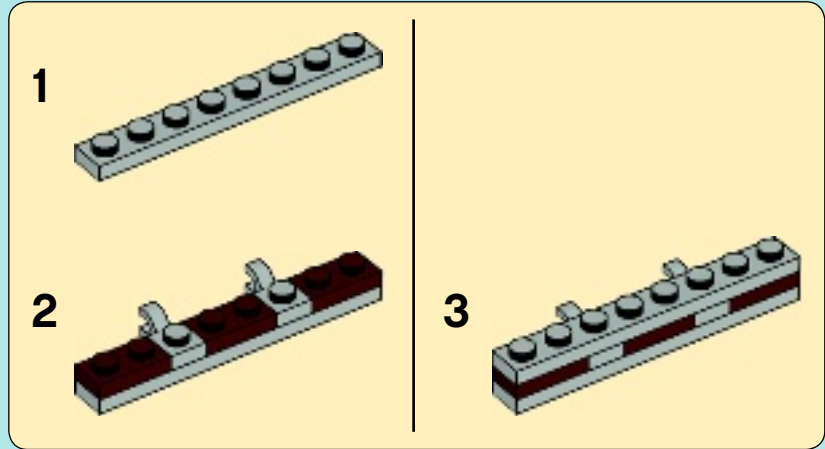



11

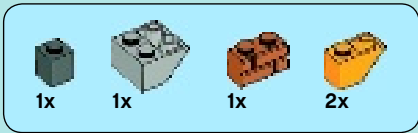
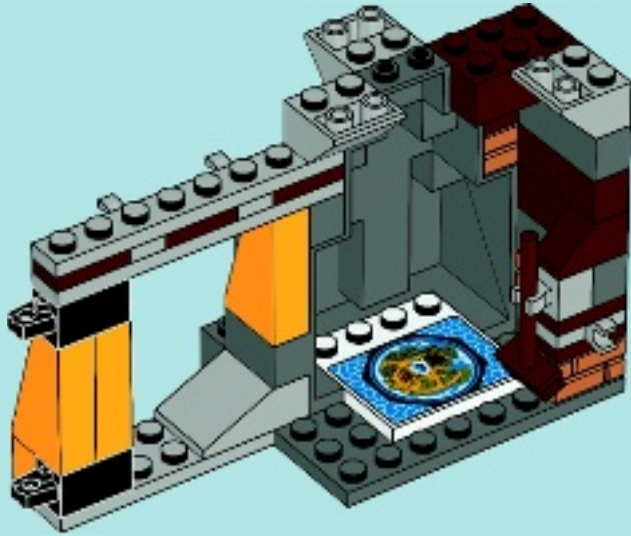

12

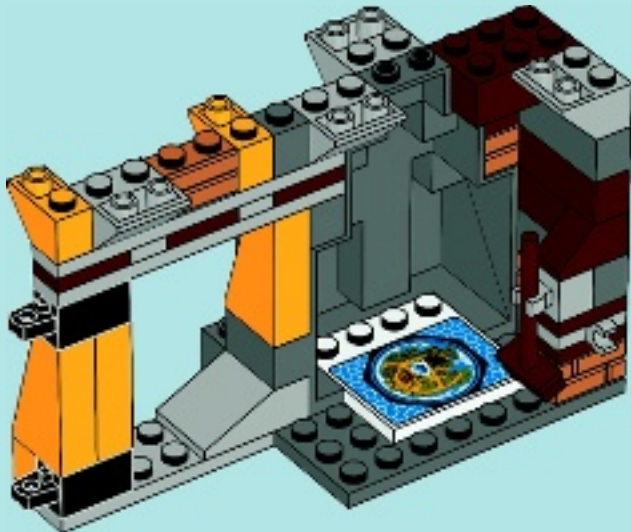

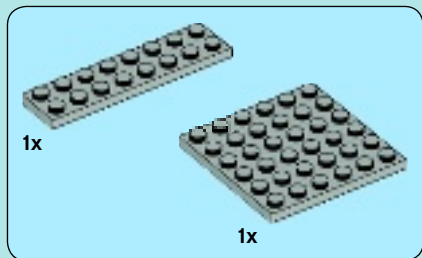

13

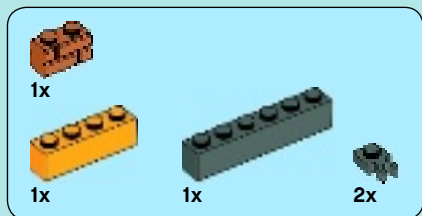
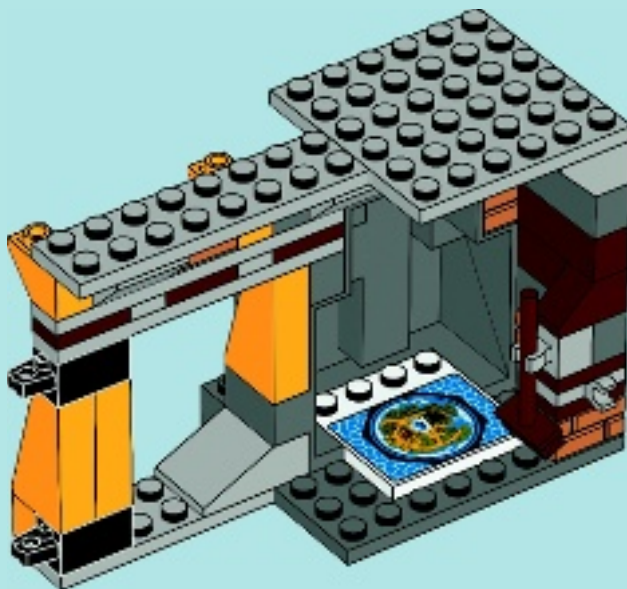

14

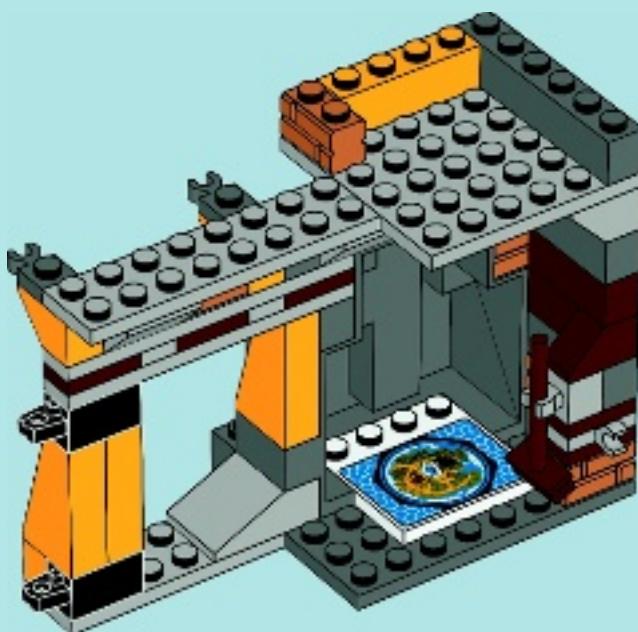





# 15

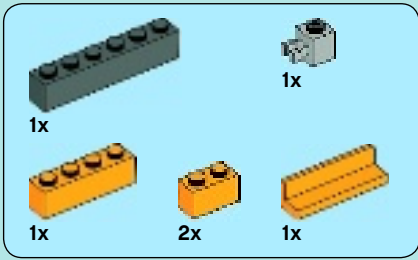
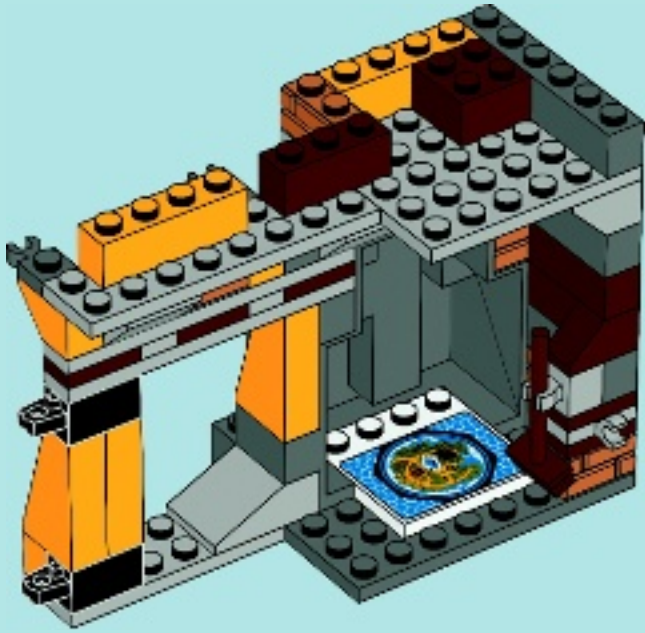

# 16

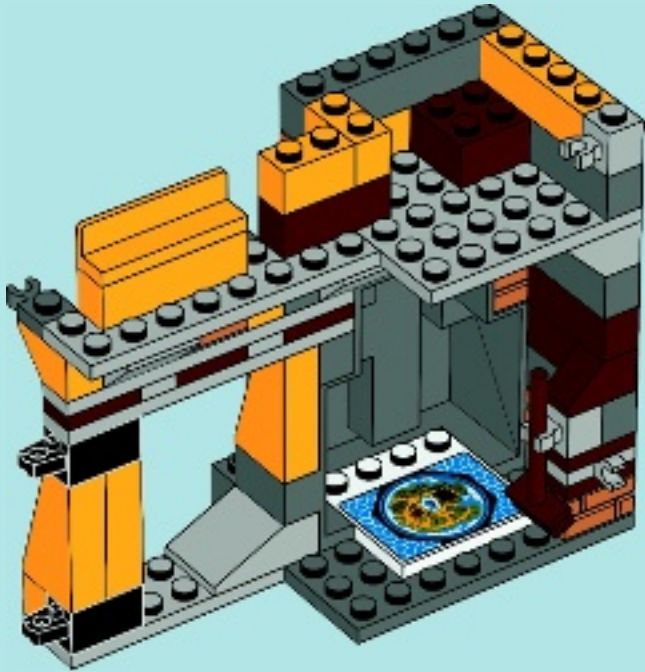

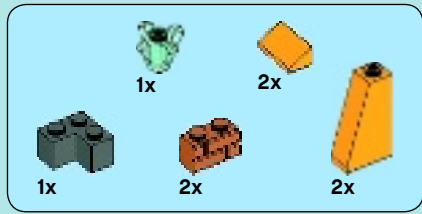

17

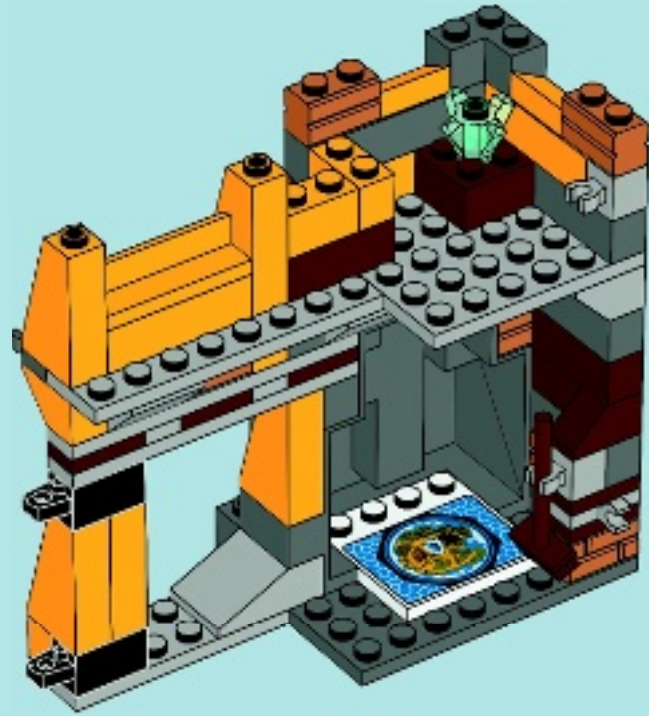

18

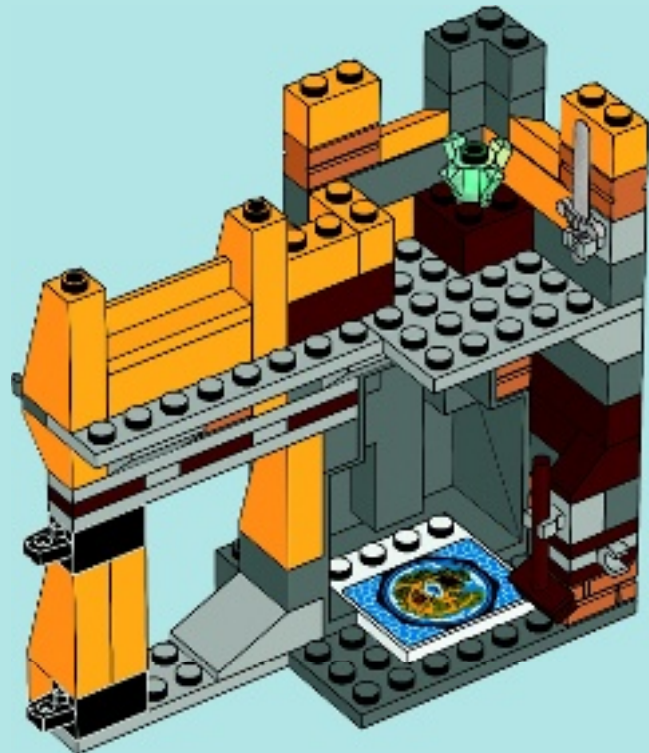

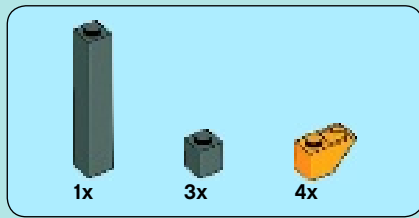

19

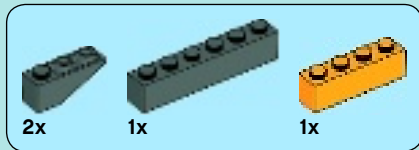
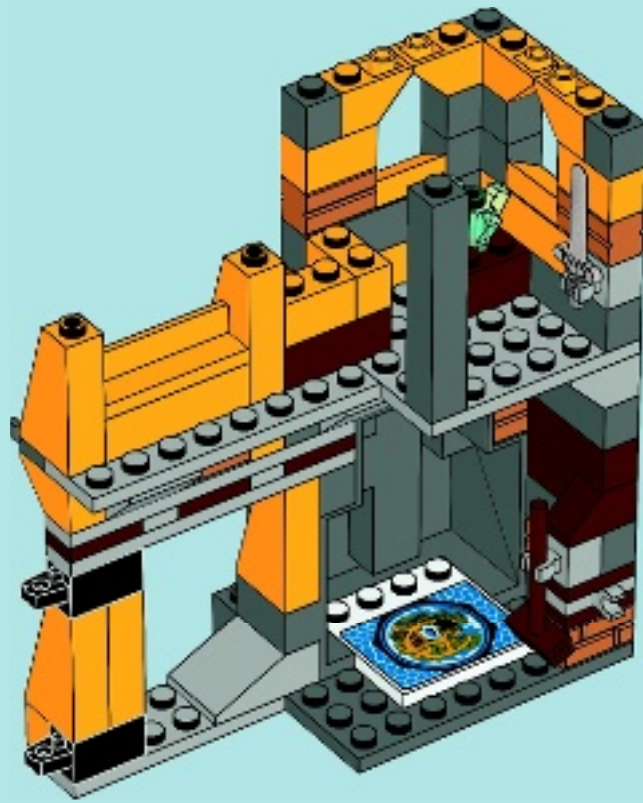

20

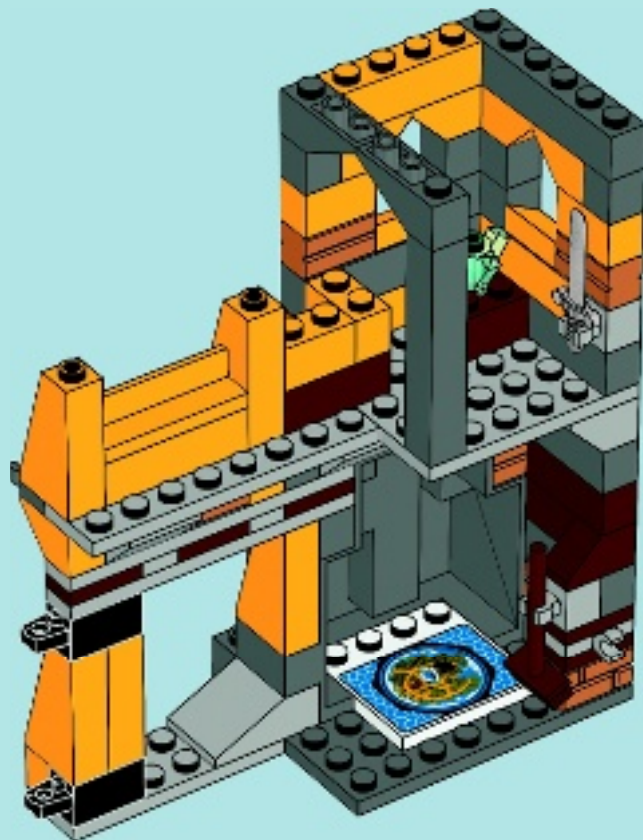

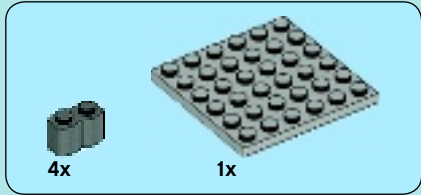

1



2

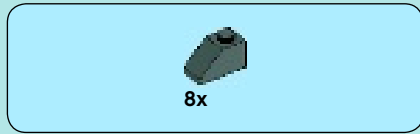
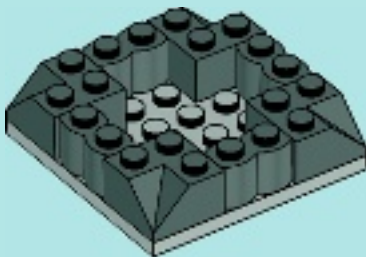

3

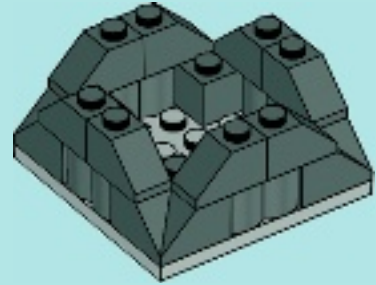

4

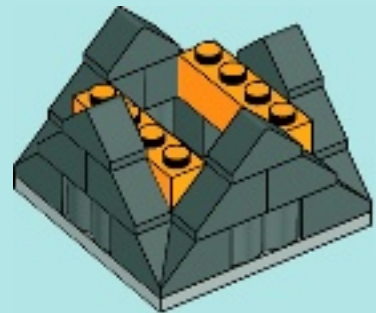

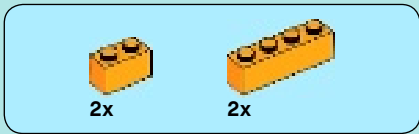

5

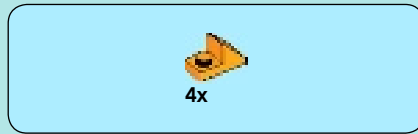
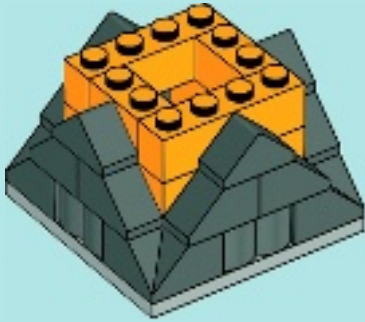

7

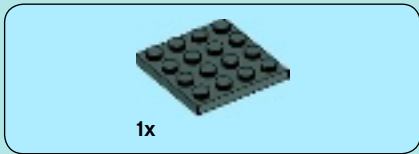
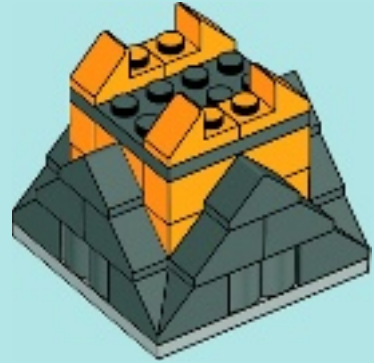

6



8

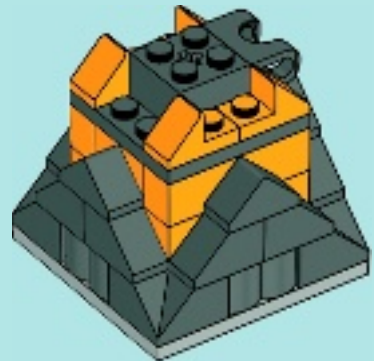



4x

9

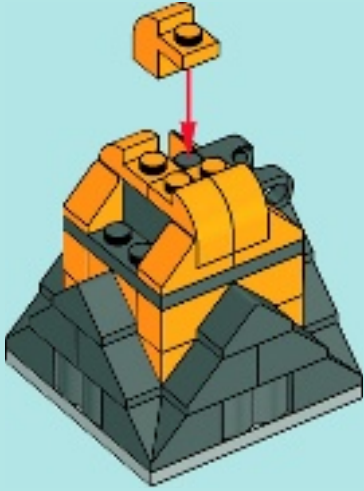

1x

10

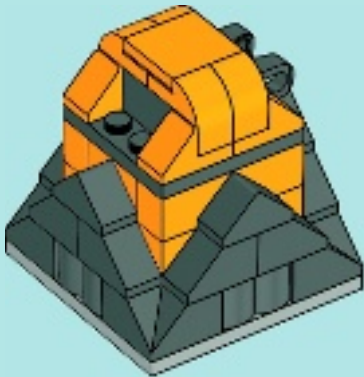

21

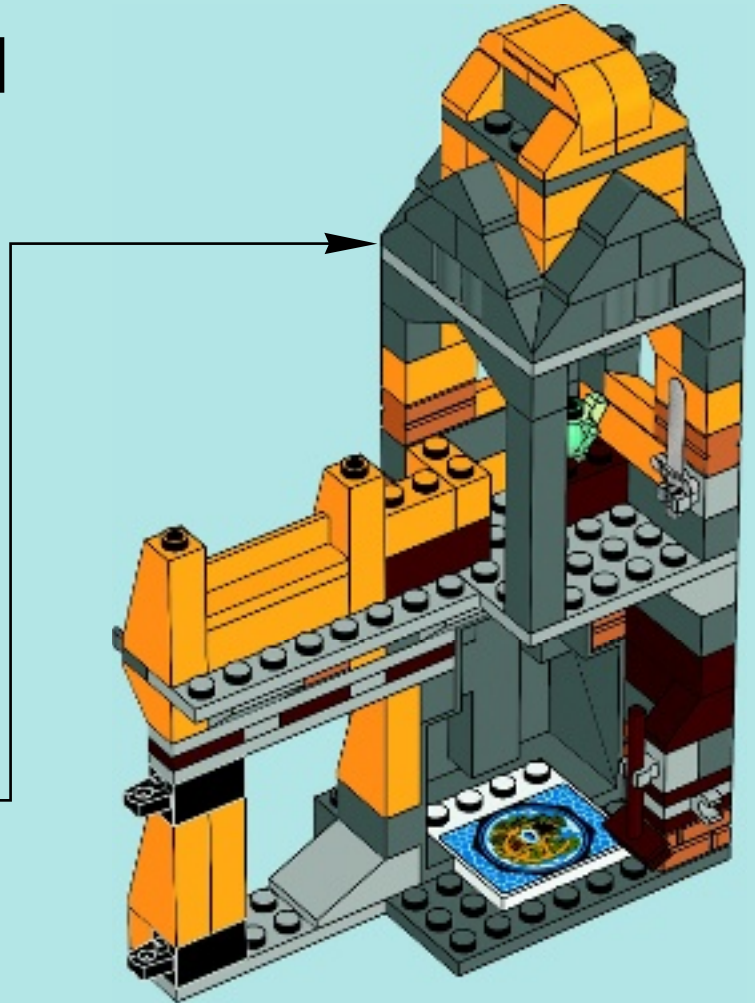

4x

22

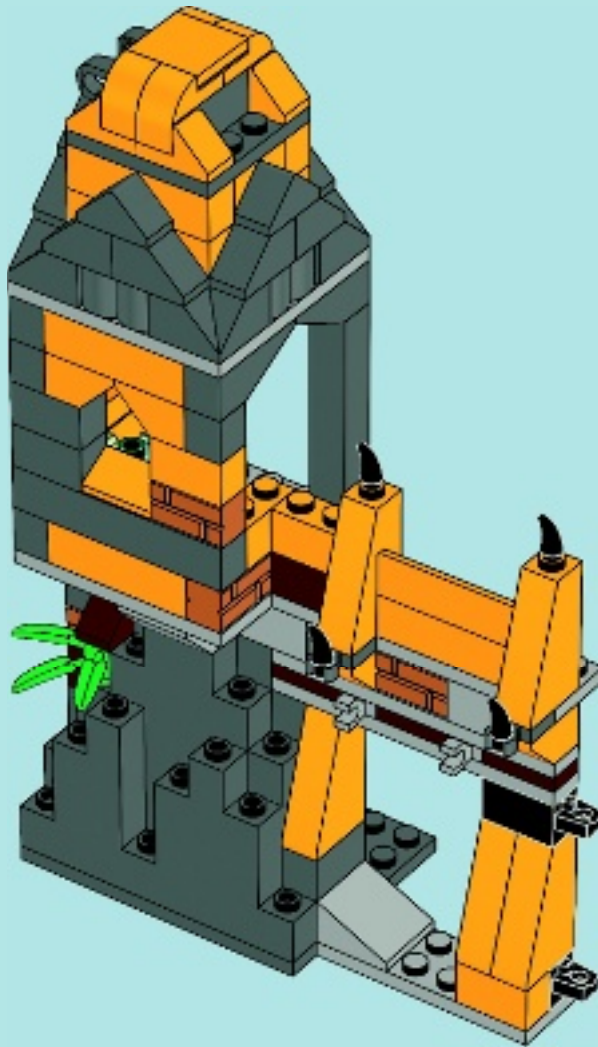
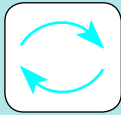

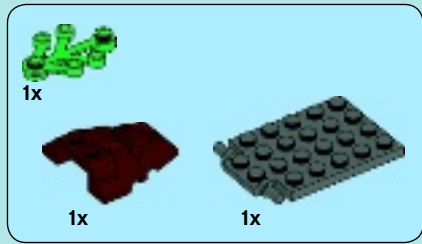

23

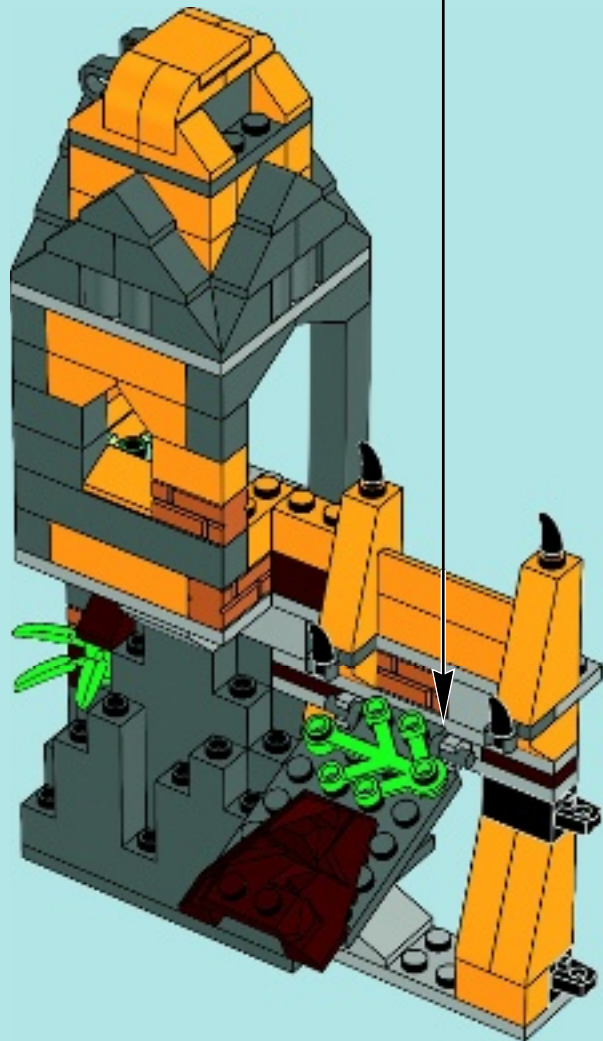
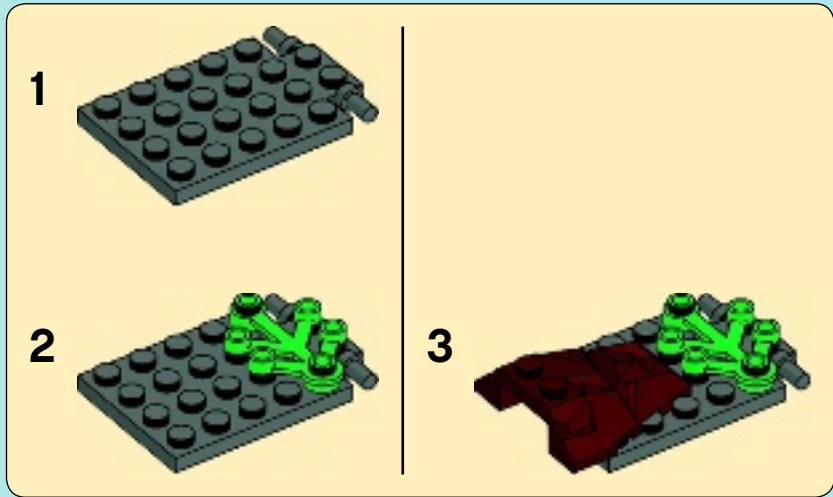



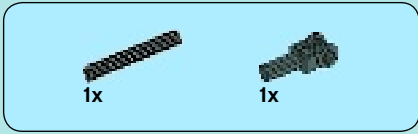
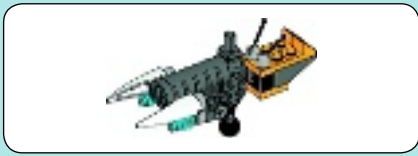

1



2

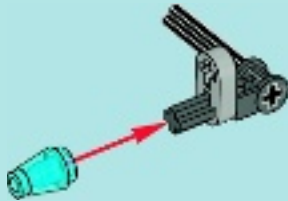

3

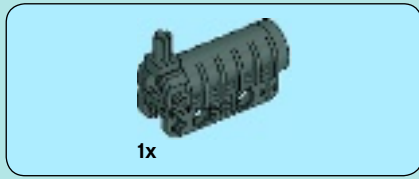
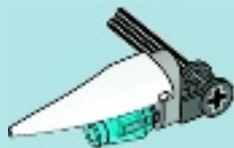

4

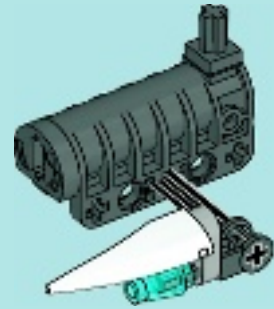

5

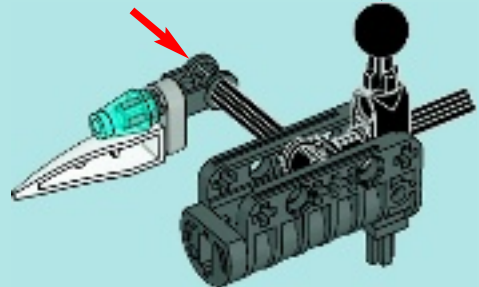
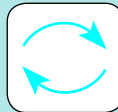
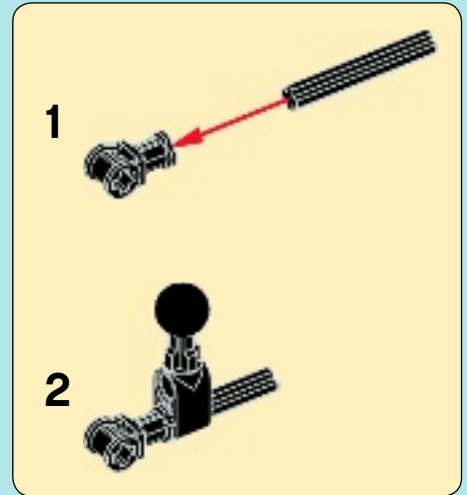



# 6

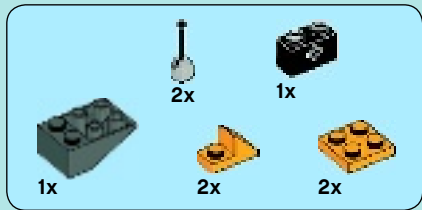
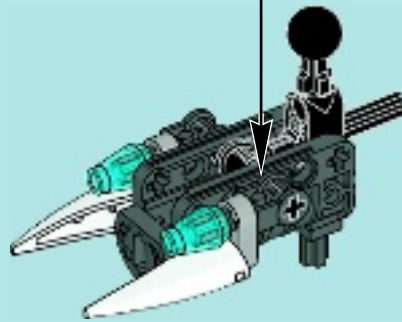
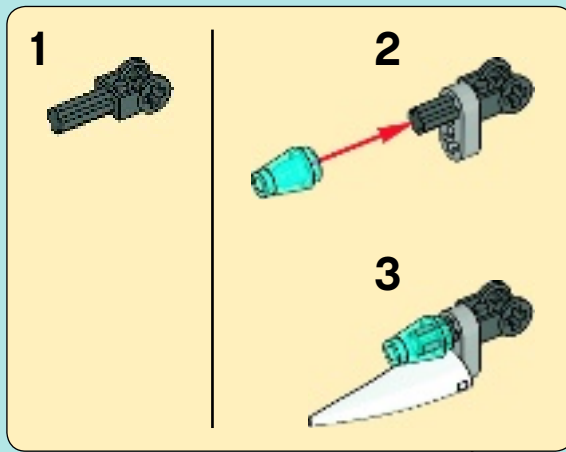

# 7

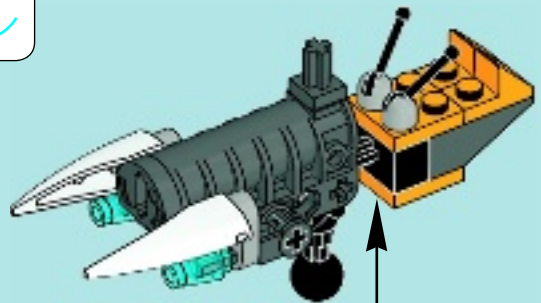
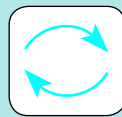
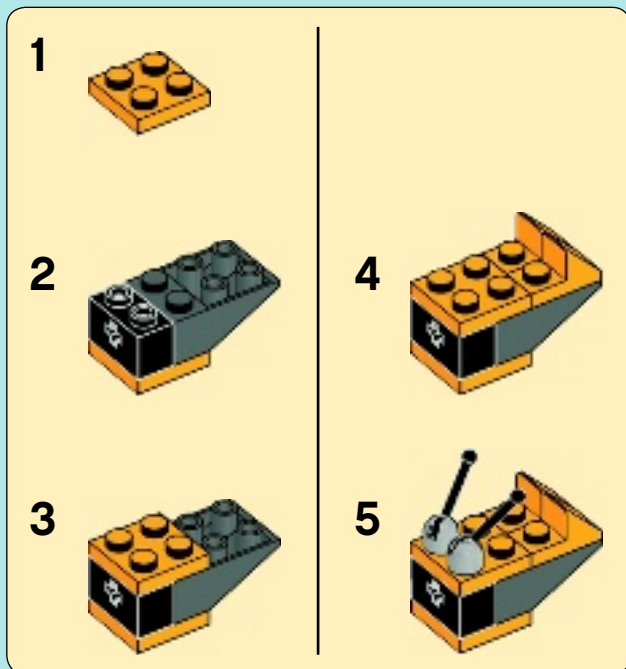

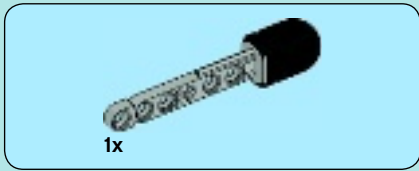

24

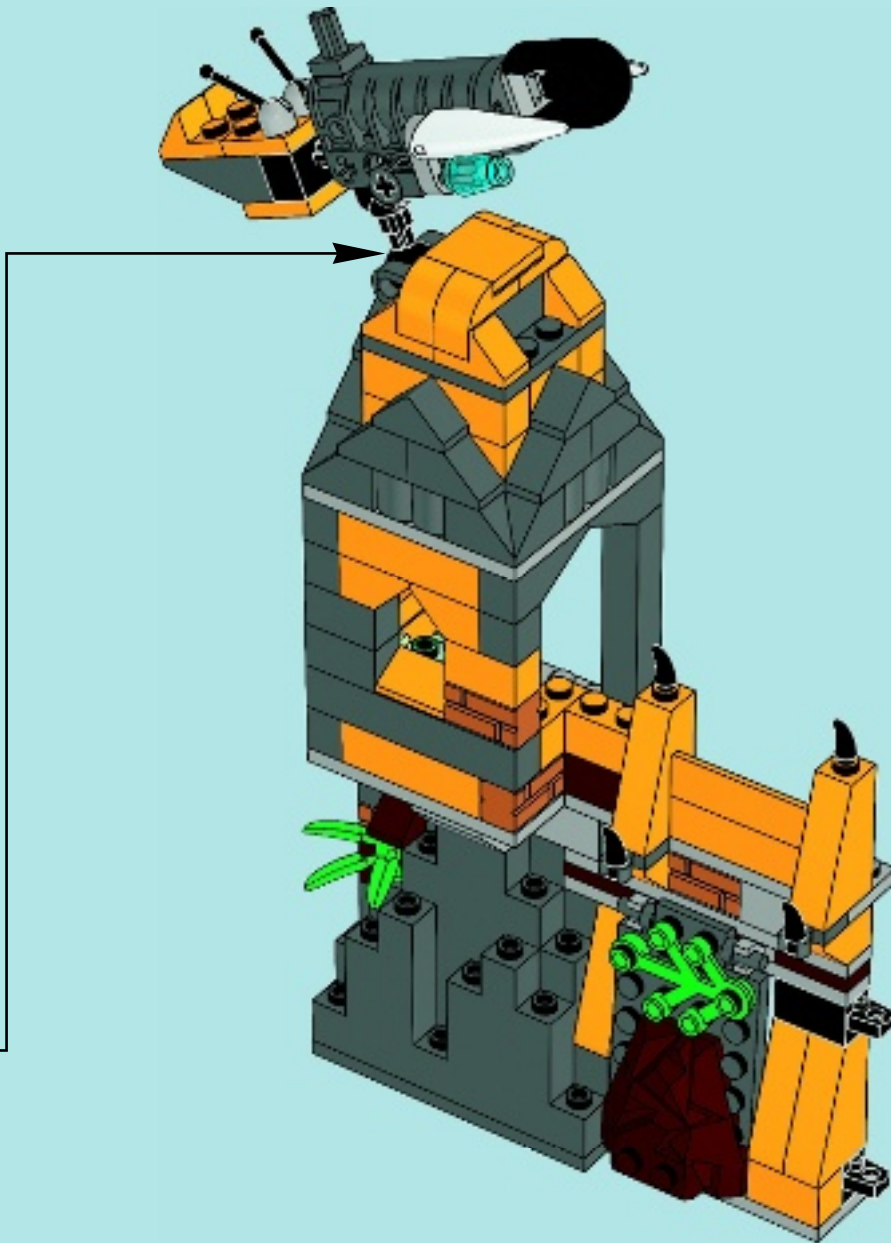

91

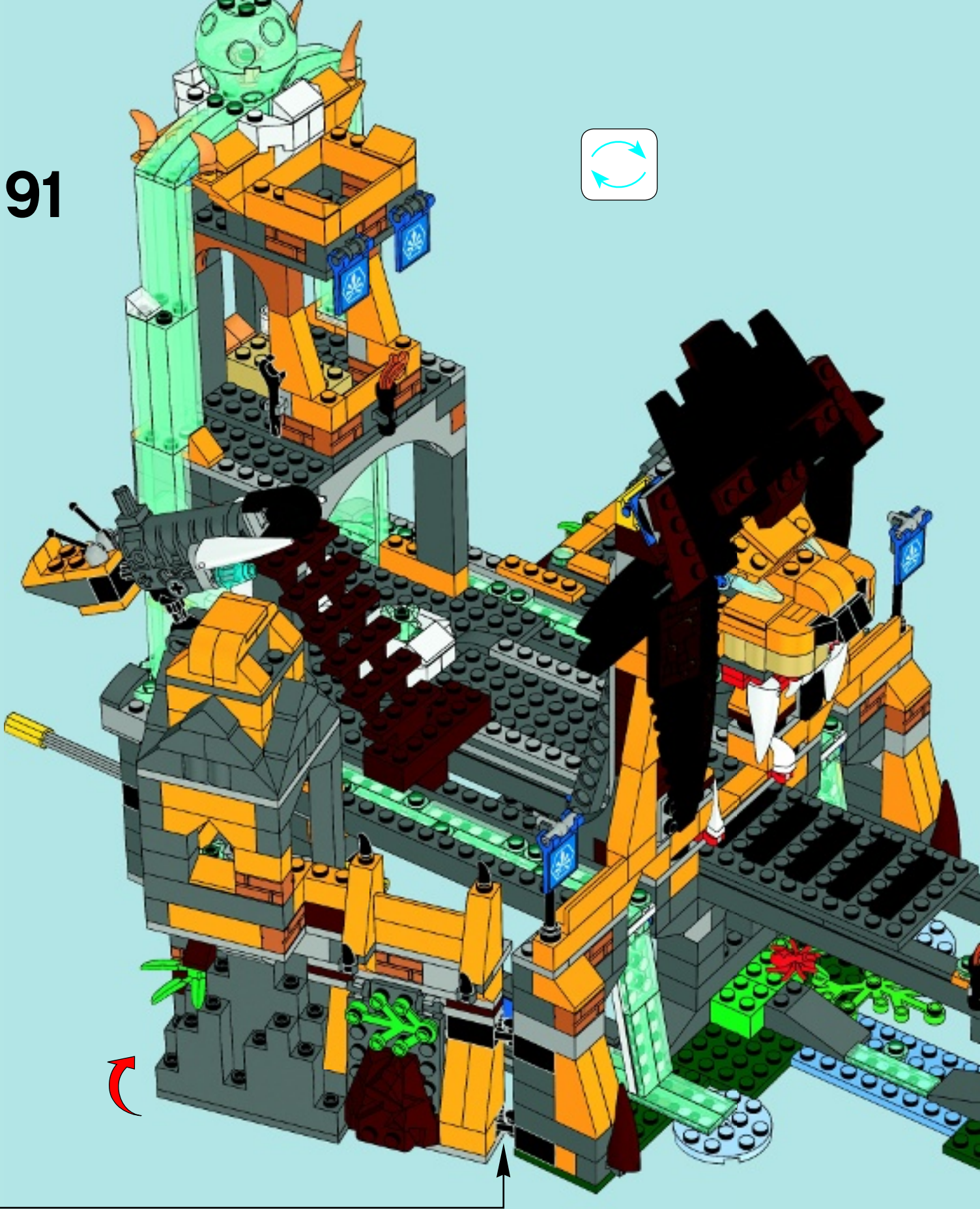
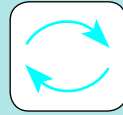



1

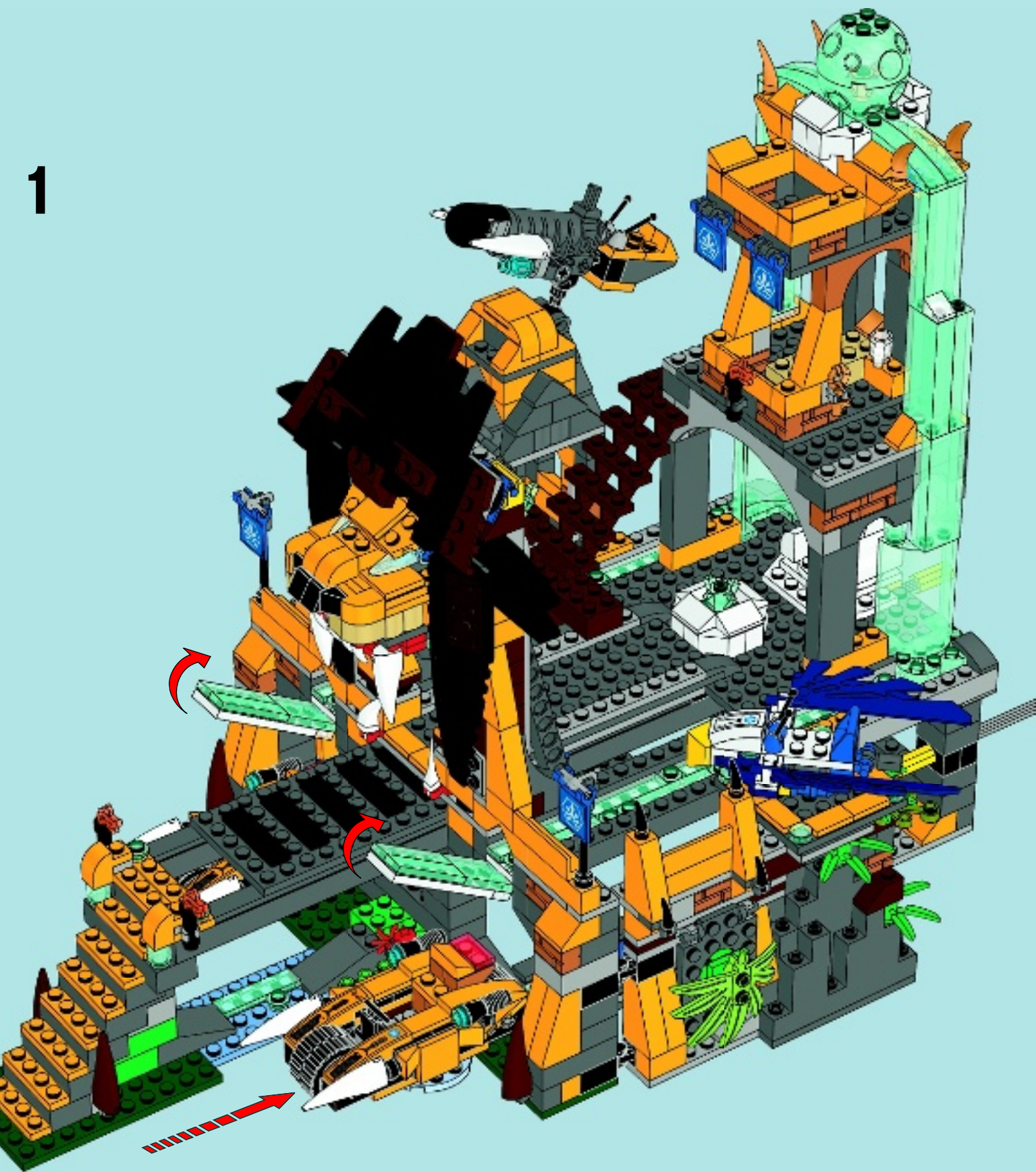

2

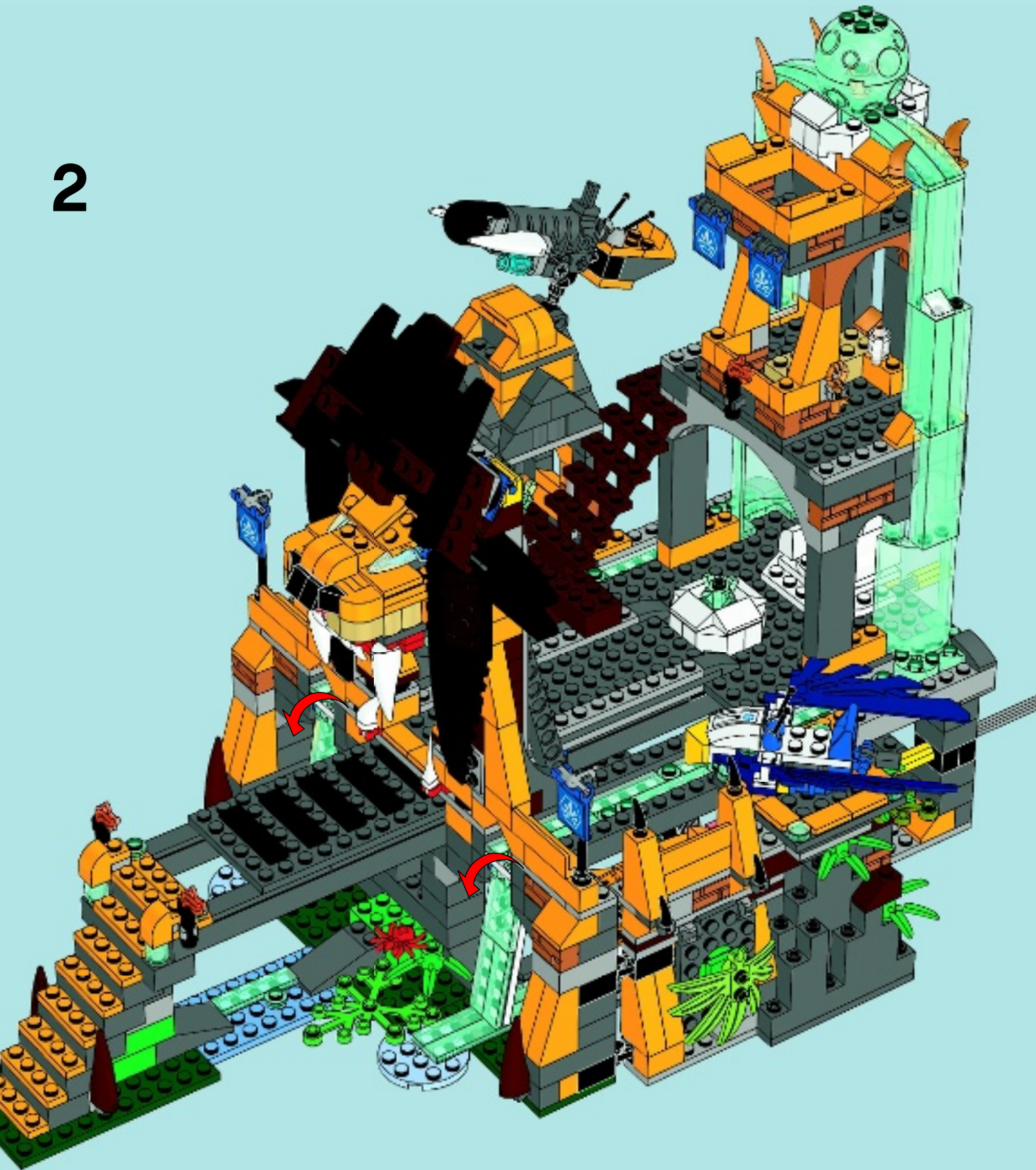

3





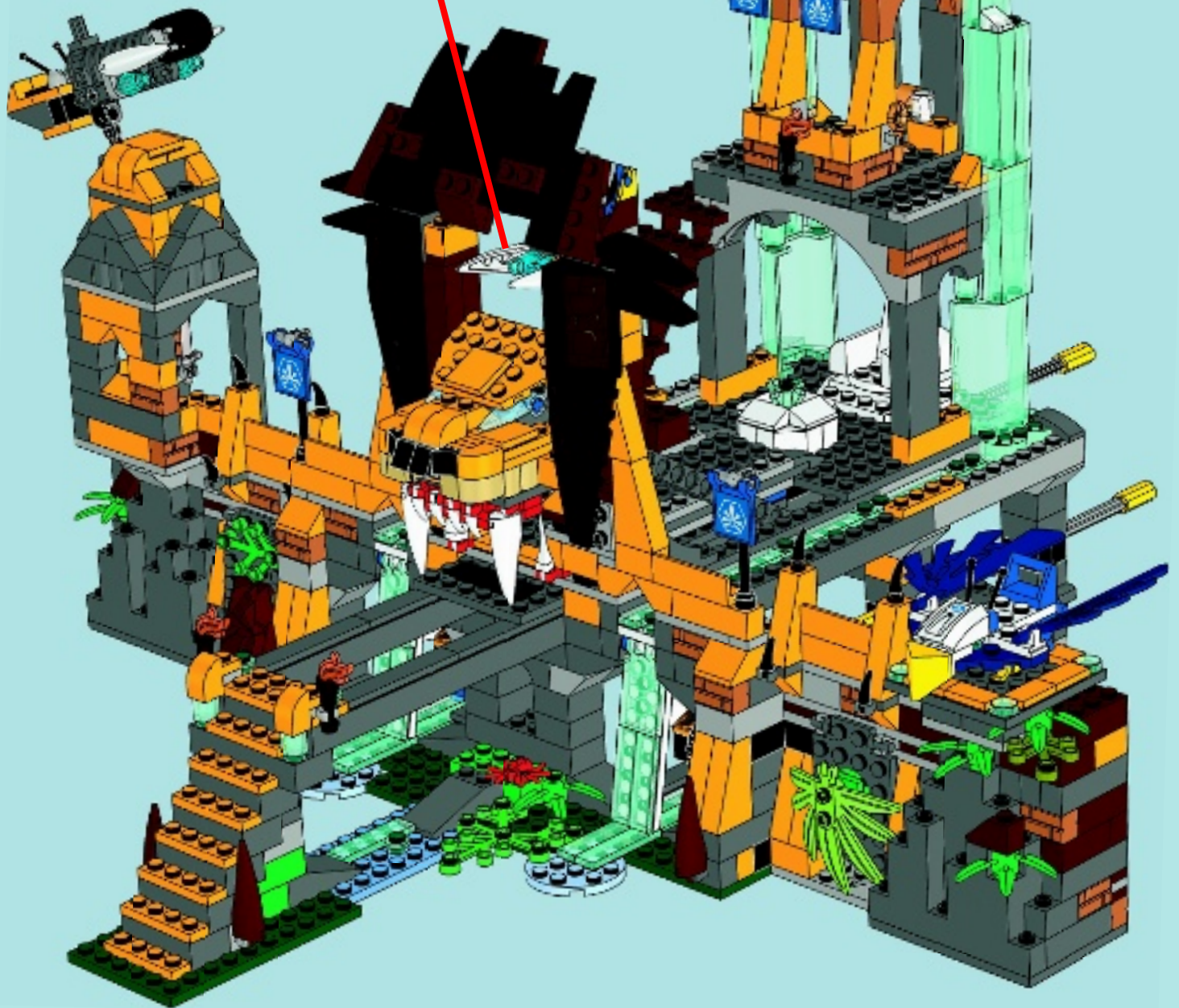
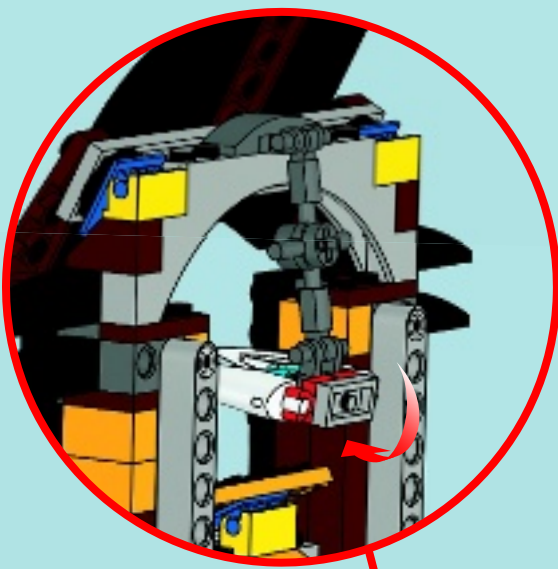

- 3x 4233486
- 8x 4560939
- 6x 4547489
- 1x 6004491
- 2x 4259937
- 2x 6019727
- 1x 302001
- 1x 617901
- 2x 4129836
- 10x 4568387
- 8x 4566256
- 10x 6015883
- 2x 6018302
- 1x 4195869
- 1x 4611927
- 2x 6030716
- 2x 4598527
- 1x 6018774
- 1x 4515347
- 1x 4508408
- 2x 379501
- 2x 383201
- 2x 4119227
- 4x 4210794
- 4x 6000970
- 2x 4256149
- 2x 4210720
- 2x 4522937
- 10x 4210783
- 2x 4216709
- 2x 4595710
- 1x 4243831
- 1x 4211115
- 2x 4210997
- 2x 4211134
- 1x 6030710
- 8x 4587212
- 2x 4579354
- 2x 6048854
- 4x 6000606
- 2x 4210660
- 1x 6013082
- 2x 4196768
- 1x 4211053
- 16x 4210651
- 2x 4211008
- 2x 4210875
- 1x 4619760
- 2x 4211042
- 1x 4535833
- 5x 6015890
- 1x 4222192
- 2x 4210665
- 1x 4518308
- 4x 4211075
- 27x 4211060
- 4x 4211109
- 9x 4211103
- 18x 4211085
- 5x 4211100
- 7x 4210999
- 4x 4211095
- 3x 4265794
- 2x 4211128
- 1x 4210690
- 11x 4211098
- 4x 4210639
- 8x 4210762
- 4x 4226221
- 8x 4211135
- 4x 4210702
- 2x 4211068
- 2x 4211045
- 5x 4211064
- 6x 4210637
- 4x 6029948
- 1x 4648256
- 2x 6005321
- 2x 4598769
- 1x 4181134
- 2x 4218749
- 2x 4273526
- 2x 4125253
- 2x 6021694
- 1x 6021598
- 1x 6021599
- 3x 403221
- 1x 370021
- 1x 371021
- 1x 302021
- 3x 366621
- 20x 4588003
- 1x 4593768
- 1x 6021789
- 1x 6022548
- 1x 6021600
- 1x 6024903
- 1x 4656767
- 3x 4140586
- 6x 4560180
- 1x 243223
- 2x 4296152
- 4x 6011816
- 1x 6022545
- 1x 6022554
- 3x 4195007
- 4x 4143005
- 4x 4206482
- 2x 4514553
- 2x 383223
- 1x 6015239
- 1x 4164073
- 2x 6015892
- 3x 393724
- 7x 4519010
- 1x 6023832
- 1x 4625528
- 1x 4613323
- 2x 6015895
- 4x 4106356
- 2x 379428
- 1x 403228
- 1x 242328
- 5x 4114348
- 1x 4129872
- 2x 4244362
- 4x 4167842
- 1x 626440
- 2x 4189801
- 2x 3005741

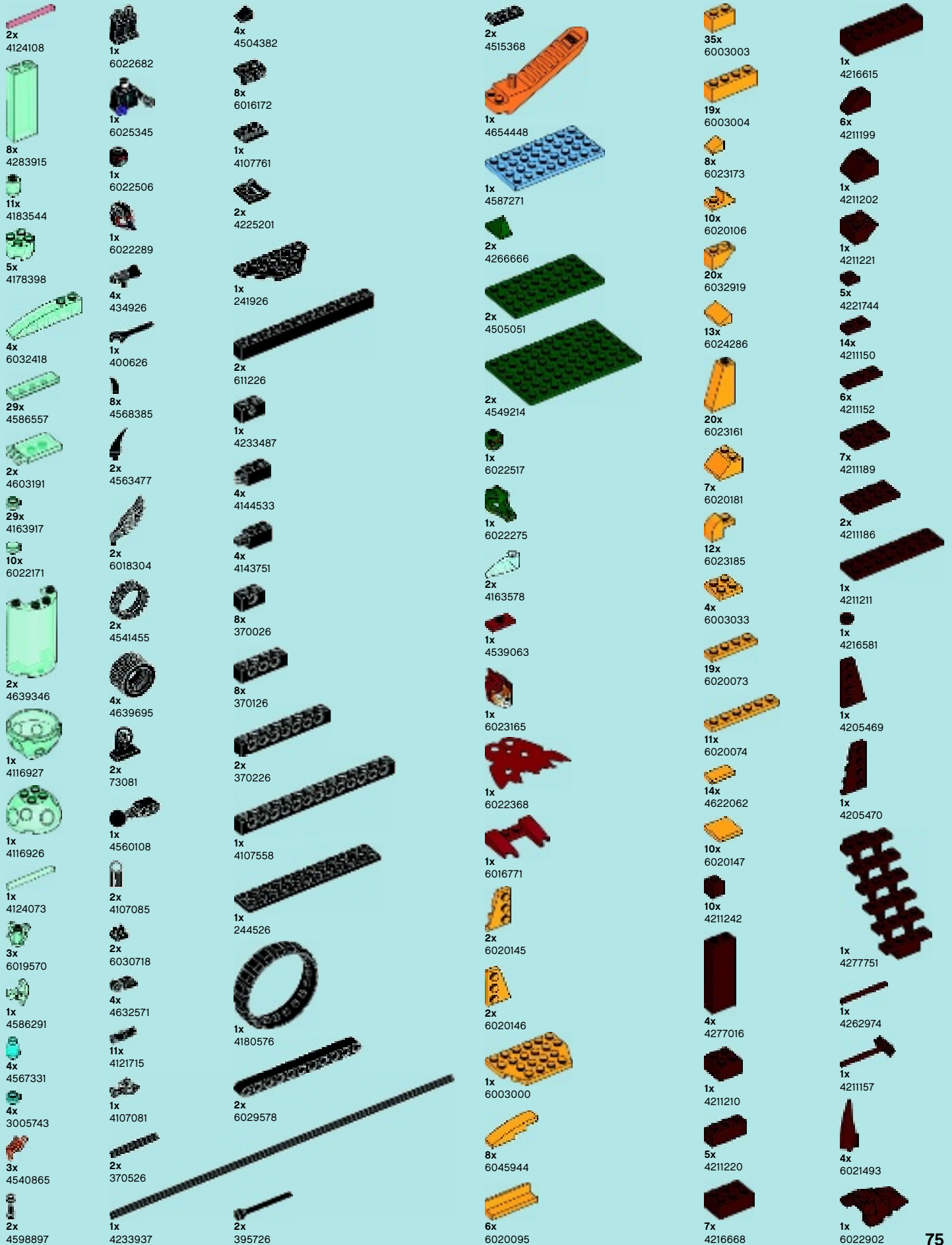

- 1x 6023163
- 1x 4539481
- 1x 4616840
- 2x 6044729
- 4x 4299119
- 1x 4258308
- 2x 4221775
- 3x 4211386
- 4x 4211521
- 7x 4533772
- 2x 6028811
- 3x 4211441
- 15x 4211436
- 2x 4211421
- 2x 4211435
- 10x 4211398
- 4x 4211397
- 4x 4211395
- 1x 4243797
- 2x 4211452
- 6x 4211425
- 2x 4211406
- 2x 4211474
- 2x 4211462
- 8x 4514846
- 2x 4211360
- 4x 4535768
- 1x 4299625
- 3x 4224592
- 2x 4542577
- 1x 4610149
- 2x 4211508

- 2x 4594238
- 4x 4541978
- 2x 6028812
- 2x 4535738
- 2x 4211413
- 2x 4211741
- 18x 4211807
- 2x 4654580
- 2x 4654577
- 8x 4211353
- 2x 4599545
- 1x 6022504
- 1x 6022033
- 5x 4587002
- 1x 6022297
- 1x 6030222
- 2x 6019994
- 1x 6019992





- 1x 4655309
- 1x 6003147
- 3x 4640843
- 1x 4646866
- 2x 6019984
- 1x 6034669
- 3x 4618195
- 4x 4611904
- 4x 4519742
- 10x 6037538
- 1x 6034199
- 1x 6034200
- 7x 4536989
- 6x 4623298
- 3x 4538950
- 1x 6023168
- 25x 4656783
- 4x 4568955
- 2x 6052788



- 1x 6022549
- 1x 6020190
- 2x 6035010
- 8x 6002841
- 1x 6016474
- 2x 6034043
- 2x 6042961
- 2x 6037669
- 2x 6016483
- 2x 6016484
- 1x 6024666
- 1x 6006425
- 2x 6023935
- 1x 6022566
- 1x 6022568
- 1x 6022516
- 1x 6022276
- 2x 6028102



**Customer Service**  
**Kundenservice**  
**Service Consommateurs**  
**Servicio Al Consumidor**

[LEGO.com/service](http://LEGO.com/service) or dial

00800 5346 5555 :     

1-800-422-5346 :  



# LEGENDS OF CHIMA™



7+



GAMES



LEGO, the LEGO logo and LEGENDS OF CHIMA are trademarks of the LEGO Group. ©2013 The LEGO Group.



LEGENDS OF

CHIMA™

70200

70203



70010



70115



70009



[LEGO.COM/CHIMA](http://LEGO.COM/CHIMA)



70010



70009



70008



70007



70200



70201



70202



70203



70204



70205



70108



70109



70114



70115



50006



# WINNI

Go to [www.LEGOsurvey.com/product](http://www.LEGOsurvey.com/product) to fill out a survey for a chance to win a cool LEGO® Product. No purchase necessary. Open to all residents where not prohibited.



## [www.LEGOsurvey.com/product](http://www.LEGOsurvey.com/product)

### GEWINNE!

Nimm an der Umfrage auf [www.LEGOsurvey.com/product](http://www.LEGOsurvey.com/product) teil und hab die Chance ein cooles LEGO® Produkt zu gewinnen! Die Teilnahme am Gewinnspiel führt zu keinerlei Kaufverpflichtungen, Teilnahme in allen nicht ausgeschlossenen Ländern möglich.

### WINNI!

Ga naar [www.LEGOsurvey.com/product](http://www.LEGOsurvey.com/product), vul een enquêteformulier in en maak kans op een cool LEGO® product. Geen aankoopverplichting. Iedereen mag deelnemen, uitzonderd ingezetenden van landen waar een enquêteverbod geldt.

### GAGNE !

Visite [www.LEGOsurvey.com/product](http://www.LEGOsurvey.com/product) pour répondre à un questionnaire et avoir une chance de gagner un produit LEGO® très COOL !  
Aucune obligation d'achat.  
Ouvert à tous les résidents des pays autorisés.

### 当てよう!

[www.LEGOsurvey.com/product](http://www.LEGOsurvey.com/product) にアクセスして、アンケートにご記入ください。当選者にはレゴ製品を差し上げます。  
お買い上げの必要はありません。  
禁止されていない限り、すべての国域にご利用いただけます。



[LEGO.com](http://LEGO.com)

6050890